

Investigation of Zero-current Switching Fixed Frequency Resonant-transition Square Wave Converters

K.W.E. Cheng and Y.P. Yeung

Department of Electrical Engineering
The Hong Kong Polytechnic University, Hung Hom, Kowloon
Fax No: (852) 23301544

Email: eeecheng@polyu.edu.hk and eeypeung@inet.polyu.edu.hk

Abstract – Most of the soft-switching converters, especially in zero-current switching resonant converters, are required to vary of switching frequency to control their output voltage. A family of newly designed zero-current switching fixed frequency square wave resonant converters is proposed. Output voltage of these converters can be controlled by the on-state period of a semiconductor switch; and therefore, they can be operated in fixed switching frequency. All of the switching devices are in zero-current switching condition. Also peak current of each switching device is minimized. Computer simulation and experimental results are presented to support the operation of the converters.

I. INTRODUCTION

Recently, resonant converters are widely used in many applications [1]. Because they are operated in soft-switching, these types of converters have high efficiency, low switching loss, low switching noise, light weight and small size in comparison with classical PWM converters. However, most resonant converters cannot be controlled by duty ratio of the gate signals. Also, for zero-current switching converters, the peak current of the switching devices is much higher than the main current.

Some extended-period zero-current switching quasi-resonant converter topologies were proposed in [2]. Those converters can be controlled by PWM. Similar to the classical quasi-resonant zero-current switching converters, the current stresses of the converters are very high.

The topologies of clamped-current PWM converter presented in [3] can be controlled by PWM and the current stress of the converters was reduced. However, the current stress is still high compared with classical hard-switching dc-dc converters. Another quasi-square wave zero-current switching resonant converter topology was presented in [4]. The current stress of this topology was reduced to be the same as classical hard-switching dc-dc converter. However, this converter is controlled by varying its switching frequency. It cannot be controlled by fixed-frequency PWM so that the control method is complicated.

A Family of zero-current switching (ZCS) fixed frequency (FF) resonant-transition (RT) square wave (SW) converters is proposed. This type of converters is operated by two switching devices. Each device is switched on and off in zero-current switching condition so that the switching losses produced and electromagnetic interference (EMI) induced by each switching device can be reduced. Moreover, the peak current of each switching device is equal to the main current and hence, the current stresses and the current ratings of the switching devices can be reduced. Also, output voltage of the converters is controlled by PWM so that frequency control is not required.

II. CIRCUITS OF ZCS-FF-RT-SW CONVERTERS

The main resonant switching circuit of the ZCS-FF-RT-SW converters is shown in Fig. 1. The capacitor C_r and the inductor L_r are the resonant components of the converter. C_1 , L_1 and L_2 are the filtering components. These two inductors also act as two current sources to keep the current constant. D_1 and D_2 are used to keep the current passing through the power transistors in single direction. Using this resonant switching circuit, a family of ZCS-FF-RT-SW converters (buck, boost and buck-boost converters) as shown in Fig. 2 can be built.

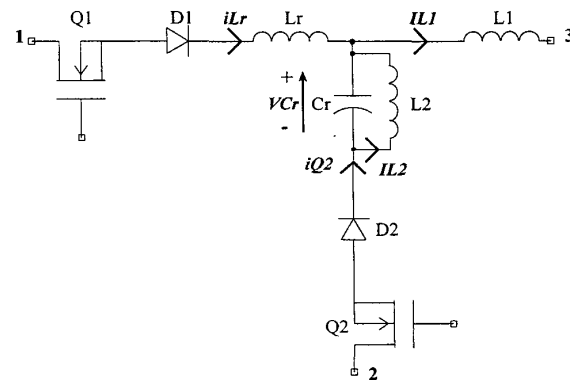
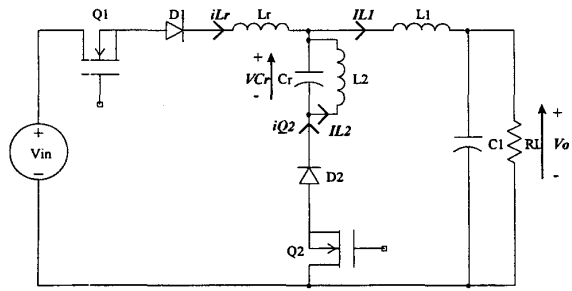
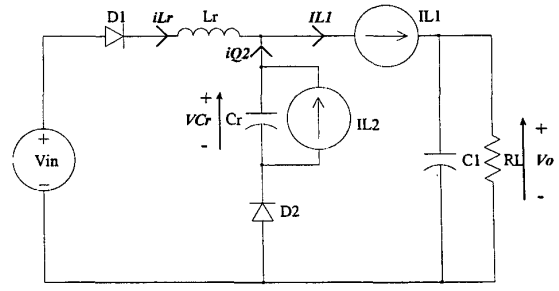

Fig. 1. Resonant Switching Circuit of ZCS-FF-RT-SW Converter



(a)



(a)

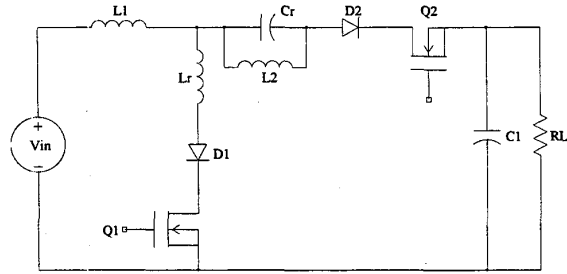

(b)

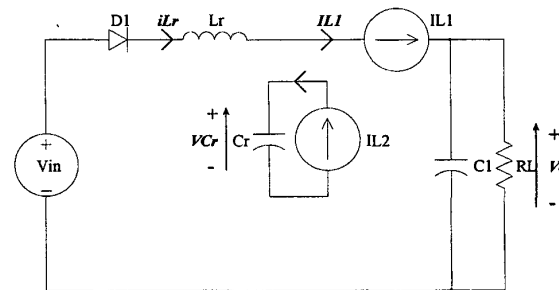

(b)

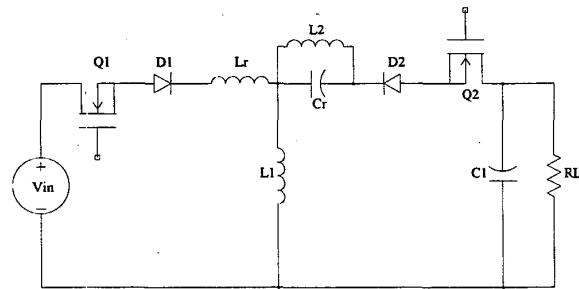

(c)

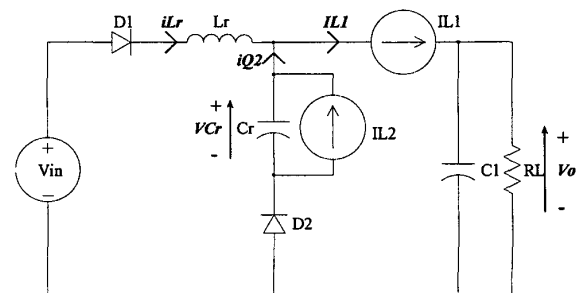

(c)

Fig. 2. Family of ZCS-FF-RT-SW Converters: (a) Buck, (b) Boost, (c) Buck-boost

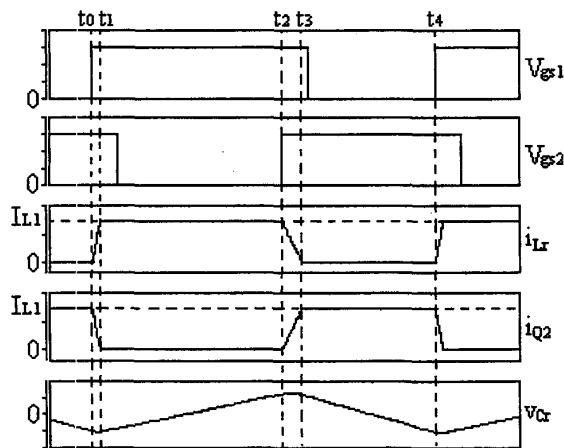
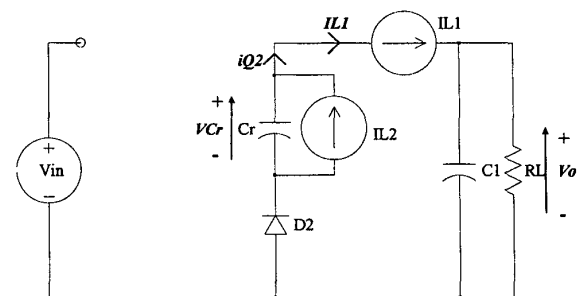

Fig. 3. Simulation Switching Waveform of ZCS-FF-RT SW Converter



(d)

Fig. 4. States of Operation of ZCS-FF-RT-SW Buck Converter: (a) State I [$t_0 - t_1$], (b) State II [$t_1 - t_2$], (c) State III [$t_2 - t_3$], (d) State IV [$t_3 - t_4$]

III. OPERATION PRINCIPLE

The ZCS-FF-RT-SW buck converter is used to explain the proposed topology. The simulated switching waveforms of the zero-current switching fixed frequency resonant-transition square wave buck converter and its equivalent circuits of each state of operation are shown in Fig. 3 and Fig. 4 respectively. The state-plane trajectory of the converter is shown in Fig. 5.

The resonant angular frequency and the resonant characteristic impedance are defined respectively as below:

$$\omega_r = \frac{1}{\sqrt{L_r C_r}} \quad (1)$$

$$Z_0 = \sqrt{\frac{L_r}{C_r}} \quad (2)$$

The base quantities of the following normalized equations are defined as:

$$\text{Base frequency} = \omega_r \quad (3)$$

$$\text{Base impedance} = Z_0 \quad (4)$$

$$\text{Base voltage} = V_{in} \quad (5)$$

$$\text{Base current} = \frac{V_{in}}{Z_0} \quad (6)$$

(a) State I [t_0 to t_1]:

In this state, both Q_1 and Q_2 are in ON state. At t_0 , i_{Q2} is equal to the filter inductor current I_{L1} while i_{Lr} is equal to zero. L_r and C_r resonate together. i_{Lr} increases gradually until i_{Lr} reaches I_{L1} . Since L_1 is large enough to maintain I_{L1} to be constant, I_{Q2} decreases to zero gradually at the same time. After I_{Q2} reaches zero, Q_2 is switched OFF after t_1 and C_r is charging. Hence, Q_1 is switched ON and Q_2 is switched off in zero current condition. The normalized equations of the resonant inductor current (L_r) and the resonant capacitor (C_r) of this state are similar to the normalized equations of [4]:

$$j_{Lr}(t) = (1 - M_{Cr0}) \sin \omega_r t + (J_{L1} - J_{L2})(1 - \cos \omega_r t) \quad (7)$$

$$m_{Cr}(t) = 1 - (M_{in} - M_{Cr0}) \cos \omega_r t - (J_{L1} - J_{L2}) \sin \omega_r t \quad (8)$$

where j_{Lr} is the normalized resonant inductor current and m_{Cr} is the normalized resonant capacitor voltage. J_{L1} is the normalized current of L_1 and J_{L2} is the normalized current of L_2 . M_{Cr0} is the normalized resonant capacitor

voltage when $t = t_0$.

Also, at $t = t_1$, the normalized resonant capacitor voltage:

$$m_{Cr}(t_1) = M_{Cr1} = \sqrt{J_{L1}^2 - 2J_{L1}J_{L2} + (1 - M_{Cr0})^2} + 1 \quad (9)$$

(b) State II [t_1 to t_2]:

In this state, Q_1 remains ON and Q_2 is switched OFF. Since L_2 is large enough to act as a current source, C_r is charging linearly by L_2 . When v_{Cr} reaches V_{in} , and if Q_2 is in ON state, D_2 will be turned ON and resonance will be occurred by C_r and L_r . However, in this case, in order to obtain higher output voltage of the converter, Q_2 is still in OFF state so that resonance does not occur until Q_2 is switched ON at t_2 . In other words, since the conversion ratio of the converter is mainly controlled by the length of this state, Q_2 should be switched OFF before v_{Cr} reaches V_{in} . The normalized equations are:

$$j_{Lr}(t) = J_{L1} \quad (10)$$

$$m_{Cr}(t) = J_{L2} \omega_r t + M_{Cr1} \quad (11)$$

At $t = t_2$, $m_{Cr} = M_{Cr2} = 1 + M'_{Cr2}$ where $M_{Cr2} \leq 1$.

Also, let $t = t'_2$ when m_{Cr} reaches 1 and $t_2 = t'_2 + \delta$. Therefore,

$$M'_{Cr2} = J_{L2} \omega_r \delta \quad (12)$$

(c) State III [t_2 to t_3]:

Q_2 is switched ON in zero current condition at t_2 while Q_1 is still in ON state. C_r and L_r resonate together. i_{Lr} decreases to gradually and meanwhile, i_{Q2} increases gradually until it reaches I_{L1} . The normalized equations of this state are:

$$j_{Lr}(t) = (J_{L1} - J_{L2}) + J_{L2} \cos \omega_r t - M'_{Cr2} \sin \omega_r t \quad (13)$$

$$m_{Cr}(t) = 1 + M'_{Cr2} \cos \omega_r t + J_{L2} \sin \omega_r t \quad (14)$$

At $t = t_3$,

$$m_{Cr}(t_3) = M_{Cr3} = \sqrt{J_{L2}^2 - (J_{L1} - J_{L2})^2 + M'_{Cr2}^2} + 1 \quad (15)$$

(d) State IV [t_3 to t_4]:

After i_{Lr} reaches zero at t_3 , Q_1 is switched OFF so that zero-current switching is obtained. Q_2 is kept to be in

ON state. C_r is discharging linearly to L_1 and to the load until Q_1 is switched on at t_4 . The normalized equations are:

$$j_{Lr} = 0 \quad (16)$$

$$m_{Cr}(t) = M_{Cr3} - (J_{L1} - J_{L2})\omega_r t \quad (17)$$

At $t = t_4$, another switching period starts. The resonant capacitor voltage at this moment is:

$$m_{Cr}(t_4) = M_{Cr4} = M_{Cr0} \quad (18)$$

IV. DC CONVERSION RATIO AND CONDITIONS FOR ZERO CURRENT SWITCHING

(a) State-Plane Trajectory

Referring to the normalized equations of each state of operation of the converter, a normalized state-plane (j_{Lr} versus m_{Cr}) of the converter is sketched which is shown in Fig. 5.

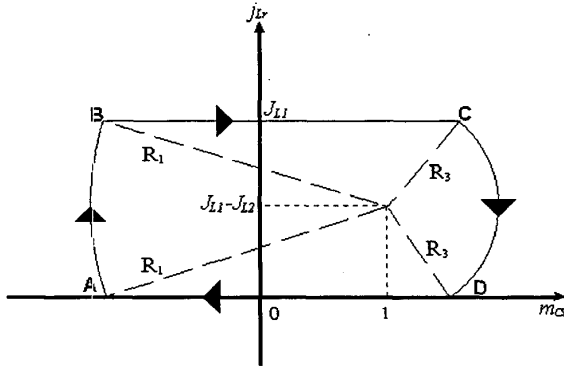

Fig. 5. Normalized State-plane of ZCS-FF-RT-SW Converter

From Fig. 5, branches AB, BC, CD and DA represent State I, State II, State III and State IV respectively.

The coordinates of each point are: A(M_{Cr0} , 0), B(M_{Cr1} , J_{L1}), C(M_{Cr2} , J_{L1}) and D(M_{Cr3} , 0).

$$R_1 = \sqrt{(J_{L1} - J_{L2})^2 + (1 - M_{Cr0})^2} \quad (19)$$

$$R_3 = \sqrt{J_{L2}^2 + (M_{Cr2} - 1)^2} \quad (20)$$

Let $D_1 = \frac{(t_1 - t_0)}{T}$, $D_2 = \frac{(t_2 - t_1)}{T}$, $D_3 = \frac{(t_3 - t_2)}{T}$ and $D_4 = \frac{(t_4 - t_3)}{T}$ where T is the switching period. Also, let

the duty ratio $D = D_1 + D_2 + D_3$ and $D_4 = 1 - D$.

The normalized resonant angular frequency $\omega_n = \omega_r \times T$. Hence,

$$D_1 = \frac{\sin^{-1} \frac{J_{L1} - J_{L2}}{R_1}}{\omega_n} \quad (21)$$

$$D_2 = \frac{\sqrt{R_1^2 - J_{L2}^2} + \sqrt{R_3^2 - J_{L2}^2}}{\omega_n J_{L2}} \quad (22)$$

$$D_3 = \frac{\sin^{-1} \frac{J_{L2}}{R_3} + \sin^{-1} \frac{J_{L1} - J_{L2}}{R_3}}{\omega_n} \quad (23)$$

$$D_4 = \frac{\sqrt{R_1^2 - (J_{L1} - J_{L2})^2} + \sqrt{R_3^2 - (J_{L1} - J_{L2})^2}}{\omega_n (J_{L1} - J_{L2})} \quad (24)$$

(b) DC Conversion Ratio

Assuming $\omega_r \gg f_s$ where f_s is the switching frequency, ω_n becomes very large so that $D_2 \gg D_1$ and D_3 . Hence, $D \approx D_2$ and $D_4 \approx 1 - D_2$.

Also, assuming the converter has no loss, input power must be equal to output power. Then,

$$P_{in} = P_{out} \quad (25)$$

$$V_{in} I_{L1} D \approx V_o I_{L1} \quad (26)$$

Therefore, the dc conversion ratio of ZCS-FF-RT-SW Buck converter:

$$M = \frac{V_o}{V_{in}} \approx D \quad (27)$$

which is approximately equal to the conversion ratio of classical hard-switching buck converter.

(c) Conditions for Zero Current Switching

In order to achieve zero current switching, from Fig. 5, R_3 should be larger than 1. Otherwise, the j_{Lr} will never return to zero before Q_1 is switched OFF.

Moreover, in state IV, Q_1 should be switched OFF before m_{Cr} reaches 1. It should be switched OFF before $t_3 + \frac{\sqrt{R_3^2 - (J_{L1} - J_{L2})^2}}{\omega_r (J_{L1} - J_{L2})}$.

V. EXPERIMENTAL RESULTS

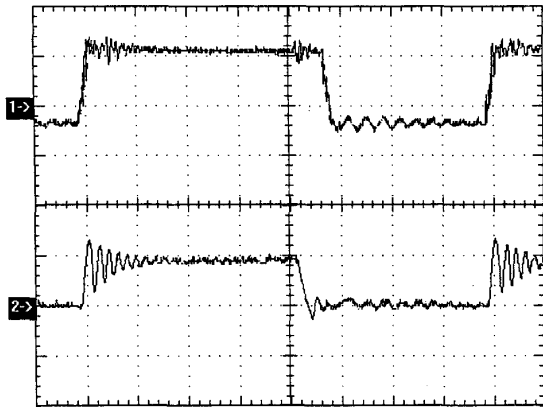

(a)

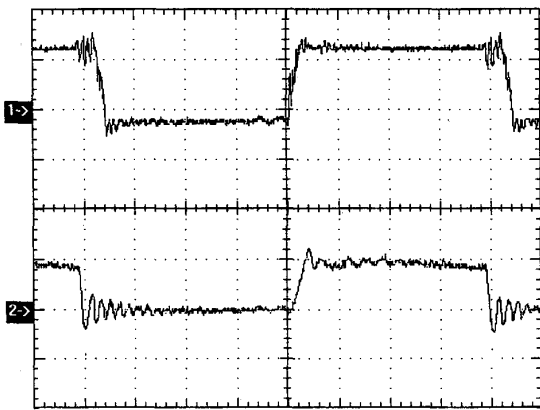

(b)

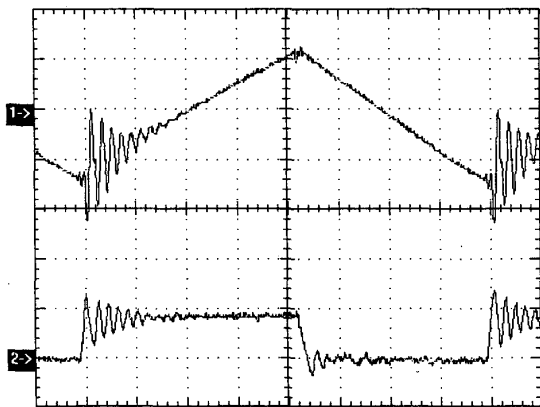

(c)

Fig. 6. Measured Waveform of ZCS-FF-RT-SW Buck Converter: (a)1, Gate Signal of Q_1 ; (a)2, i_{Lr} ; (b)1, Gate Signal of Q_2 ; (b)2, i_{Q2} ; (c)1, v_{Cr} ; (c)2, i_{Lr} . Scale: Gate Signal of Q_1 and Q_2 : 10V/div; v_{Cr} : 40V/Div; i_{Lr} and i_{Q2} : 500mA/div; Horizontal Scale: 1 μ s/div.

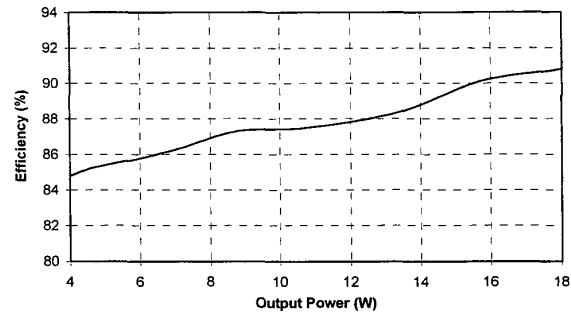

Fig. 7. Graph of Measured Efficiency vs. Output Power

A zero-current switching fixed-frequency resonant-transition square-wave buck converter shown in Fig. 1 was constructed connecting with pure resistance loads to the outline specification:

Input voltage, V_{in}	=	30V
Output power	=	4W – 18W
Switching frequency	=	125kHz

The chosen components are:

MOSFETs, Q_1 and Q_2	=	IRF840
Diodes, D_1, D_2	=	MUR860
C_r	=	0.01 μ F
L_r	=	8.1 μ H
C_1	=	470 μ F
L_1 and L_2	=	5mH

The circuit has been simulated using the above specification and has been shown in Fig. 5. No intention has been made to simulate the second order parasitic oscillation. A prototype converter using the same specification has been designed, built and tested. The measured waveforms for 8W of output power are shown in Fig. 6. This figure shows that each device of the ZCS-FF-RT-SW converter is in zero current switching condition. The current stress of each switching device is much lower than the conventional quasi-resonant zero current switching converters. Because of the junction capacitance of the MOSFET, stray capacitance and the inductors of the circuit, oscillation is appeared in the current waveform of each switching device.

The relationship between the measured efficiency and the output power of the converter is shown in Fig. 7. This graph shows that the efficiency of the converter is higher than 90% when the output power is high

VI. CONCLUSION

The family of zero-current switching (ZCS) fixed frequency (FF) resonant-transition (RT) square wave (SW) converters has been proposed. A ZCS-FF-RT-SW

buck converter has been described. Operation and characteristics of the converters have been shown and analyzed. Each switching device is under zero current soft-switching. The current stress of each switching device is much lower than the conventional quasi-resonant zero current switching converters. The dc voltage conversion ratio of the converter can also be regulated by PWM with fixed frequency.

VII. ACKNOWLEDGEMENT

The authors gratefully acknowledge the financial support of Research Grants Council CERG, HK.

VIII. REFERENCES

1. K. Liu, R. Oruganti, and F.C. Lee, "Quasi-Resonant Converters-Topologies and Characteristics", IEE Trans. on Power Electronics, vol. 2, no. 1, pp. 62-71, January 1987.
2. K.W.E. Cheng and P.D. Evans, "A Family of Extended Period Circuits for Power Supply Applications, Using High Conversion Frequencies", EPE, vol. 4, pp. 225-230, 1991.
3. B.T. Lin, K.W. Siu and Y.S. Lee, "Actively Clamped Zero-Current-Switching Quasi-Resonant Converters using IGBT's", IEEE Trans. on Industrial Electronics, vol. 46, no. 1, pp. 75-81, February 1999.
4. E. Ismail and A. Sebzali, "A New Class of Quasi-Square Wave Resonant Converters with ZCS", PEPS97 Record, 28th Annual IEEE Power Electronics Specialists Conference, vol. 2, pp. 1381-1387.