



# Heterogeneous epidemic modelling within an enclosed space and corresponding Bayesian estimation



Conghua Wen <sup>a</sup>, Junwei Wei <sup>a</sup>, Zheng Fei Ma <sup>b</sup>, Mu He <sup>c,\*</sup>, Shi Zhao <sup>d,e</sup>,  
Jiayu Ji <sup>f</sup>, Daihai He <sup>g,\*\*</sup>

<sup>a</sup> Department of Financial and Actuarial Mathematics, School of Science, Xi'an Jiaotong-Liverpool University, China

<sup>b</sup> Department of Health and Environmental Science, School of Science, Xi'an Jiaotong-Liverpool University, China

<sup>c</sup> Department of Foundational Mathematics, School of Science, Xi'an Jiaotong-Liverpool University, China

<sup>d</sup> JC School of Public Health and Primary Care, Chinese University of Hong Kong, Hong Kong, China

<sup>e</sup> CUHK Shenzhen Research Institute, Shenzhen, China

<sup>f</sup> Department of Kinesiology & Physical Education, University of Toronto, CA, Canada

<sup>g</sup> Department of Applied Mathematics, Hong Kong Polytechnic University, Hong Kong, China

## ARTICLE INFO

### Article history:

Received 1 January 2022

Received in revised form 7 February 2022

Accepted 9 February 2022

Available online 10 March 2022

Handling Editor: Dr Lou Yijun

### Keywords:

COVID-19

Epidemic model

Incubation period

Transmission

## ABSTRACT

Since March 11th, 2020, COVID-19 has been a global pandemic for more than one years due to a long and infectious incubation period. This paper establishes a heterogeneous epidemic model that divides the incubation period into infectious and non-infectious and employs the Bayesian framework to model the 'Diamond Princess' enclosed space incident. The heterogeneity includes two different identities, two transmission methods, two different-size rooms, and six transmission stages. This model is also applicable to similar mixed structures, including closed schools, hospitals, and communities. As the COVID-19 pandemic continues, our mathematical modeling can provide management insights to the governments and policymakers on how the COVID-19 disease has spread and what prevention strategies still need to be taken.

© 2022 The Authors. Publishing services by Elsevier B.V. on behalf of KeAi Communications Co. Ltd. This is an open access article under the CC BY-NC-ND license (<http://creativecommons.org/licenses/by-nc-nd/4.0/>).

## 1. Introduction

Since March 11th, 2020, the coronavirus disease 2019 (COVID-19) caused by a novel severe acute respiratory syndrome coronavirus has risen to a global pandemic. As of Nov 2021, over 258 million cases and 5.16 million deaths are reported worldwide (WHO, 2020).

Understanding the epidemic spreading of the coronavirus and the effectiveness of various countermeasures is of high interest for public health and society. Among the mathematical epidemiology studies, the burst of breakout in confined spaces, including prisons, schools, churches, and hospitals, has raised concerns widely due to its important influences in surveillance (Chu et al., 2020; Emery et al., 2020; Gan et al., 2020; Kim, 2020). One typical dataset on the cruise ship 'Diamond Princess' has been studied intensely (Azimi et al., 2021; Huang et al., 2021; Mizumoto et al., 2020).

\* Corresponding author.

\*\* Corresponding author.

E-mail addresses: [mu.he@xjtlu.edu.cn](mailto:mu.he@xjtlu.edu.cn) (M. He), [daihai.he@polyu.edu.hk](mailto:daihai.he@polyu.edu.hk) (D. He).

Peer review under responsibility of KeAi Communications Co., Ltd.

The COVID-19 outbreak on the cruise ship 'Diamond Princess' captures several researchers' attention due to its enclosed environment and relatively complete data (Azimi et al., 2021; Huang et al., 2021; Mizumoto et al., 2020). However, most of these studies did not consider some critical parameters in their corresponding models (Emery et al., 2020; Ivorra et al., 2020; Lin et al., 2020; Liu et al., 2020a, 2020b). For example, a study by Liu et al. used a heterogeneous susceptible-infectious-removed (SIR) model to fit the data on the 'Diamond Princess' cruise ship without taking into account the incubation period, which contains contact and non-contact (airborne) transmission (Liu et al., 2020b). On the other hand, another study by Emery et al. added more compartments to the SIR model, covering E (exposed), P (pre-symptomatic), and A (asymptomatic) (Emery et al., 2020). The SEPAIR model fixing the incubation period aims at inferring the spread contribution of asymptomatic cases. Another common practice is to fix one or more parameters (such as incubation period, the number of close contact people, etc.) to infer other parameters (mainly containing infectious rates) in the corresponding model, such as (Huang et al., 2021; Rocklöv, Sjödin, & Wilder-Smith, 2020a, 2020b). However, such assumptions may lead to bias in the estimation, as Yao et al. (Yao et al., 2020) indicated that the SARS-CoV-2 mutated at least 30 distinct strains, whose pathogenicity could vary by 270 times by April 2020.

This paper introduces a heterogeneous susceptible-exposed-asymptomatic-infectious-diagnosed (SEAIJ) model containing two infection sources (asymptomatic and symptomatic patients) based on the data collected from the cruise ship 'Diamond Princess'. Moreover, our model takes into account heterogeneous identities (agent-based), heterogeneous transmission schemes (in-the-room and out-of-the-room), heterogeneous room mixture (double rooms and triple rooms), and six stages of transmission (based on isolation, etc.). The proposed model and corresponding estimation method are completely data-driven. They would provide useful implications for the public health policymakers who implement control and prevention measures in enclosed communities, such as campuses and hospitals.

## 2. Materials and methods

### 2.1. The COVID-19 outbreak on the cruise ship 'Diamond Princess'

The cruise ship 'Diamond Princess' began sailing on January 20th, 2020, from Yokohama with one patient in the incubation period. There were 2666 passengers and 1045 crew members on the cruise ship, respectfully staying in double and triple rooms. The original patient was an asymptomatic passenger boarded on January 20th. He became symptomatic on January 23rd and disembarked with his two healthy daughters two days later. The cruise ship was quarantined at sea after finding more diagnoses. All passengers were quarantined in their rooms and were allowed a short time to go out daily, while all crew members wore masks to continue providing services. The passengers and the crew began to disembark on February 17th and complete disembarkation on March 1st. A total of 712 people (excluded the original patient) were confirmed on board, excluding fifty-six who became ill after disembarking. Of these, 331 were asymptomatic.

We divide the outbreak on the 'Diamond Princess' into six stages (Table 1). At the first three stages, people walked around the cruise ship freely. The first stage took place while the original patient was in the infectious incubation period. The primary infection source was the original patient. The second stage involved the original patient in the symptomatic period until he disembarked. The original patient was more contagious than he was at the first stage due to his onset. The potential infection sources were the people in the infectious incubation period who the original patient infected. The third stage was from when the original patient disembarked to the time of quarantine at sea. The infection sources were the infected people who stayed on the cruise ship. A few patients became symptomatic at the end of this stage. The fourth stage was from the time of quarantine to the time of disembarkation. All the passengers were restricted in movement while the masked crew served passengers. So the main spread scheme was the in-the-room transmission. The fifth stage was the disembarkation period. The people whose nucleic acid test came back negative were permitted to disembark. The cases reported at this stage were mainly the close contacts of the isolated patients. The sixth stage was the observation period after all the people left. Since there was no transmission on the cruise ship, the cases reported at this stage were infected at the fifth stage and tested positive at this stage (see Table 2).

### 2.2. The SEAIJ epidemic model on a cruise ship

The SEAIJ epidemic model divides the population ( $N$ ) into 5 groups, including the susceptible people ( $S$ ), the exposed people ( $E$ ), the asymptomatic people ( $A$ ), the infectious people ( $I$ ), and the diagnosed people ( $J$ ). The basic SEAIJ model is expressed in the following differential equations:

**Table 1**  
The stages of outbreak.

Stage	Period	Description
1	Jan. 20th - Jan. 22nd	Patient O in the incubation period
2	Jan. 23rd - Jan. 24th	Patient O in symptomatic period and disembarked on Jan. 25th
3	Jan. 25th - Feb. 4th	Before quarantining
4	Feb. 5th - Feb. 16th	Quarantining before disembarkation of all people
5	Feb. 17th - Mar. 1st	Disembarkation period
6	Mar. 2nd - Mar. 16th	Observation period of the last people disembarked from the ship

**Table 2**  
Notations of models.

---

<b>S</b>	The number of susceptible people who may be infected and become exposed after close contact with asymptomatic people or infectious people. The nucleic acid test results of susceptible people are negative.
<b>E</b>	The number of exposed people who are in the incubation period and without infectiousness. The nucleic acid test results of the exposed people are negative.
<b>A</b>	The number of asymptomatic people who are able to infect susceptible people during the incubation period. The nucleic acid test results of asymptomatic people are positive.
<b>I</b>	The number of infectious people who have symptoms of COVID-19 and are more contagious than asymptomatic people. The nucleic acid test results of infectious people are positive.
<b>J</b>	The number of diagonal people whose nucleic acid test results are positive and isolated from the population.
<b>N</b>	The total number of people onboard.
<b>c</b>	The number of people that each person close contacts with on average.
<b>c<sub>pp</sub></b>	The number of passengers that each passenger close contacts with on average.
<b>c<sub>pw</sub></b>	The number of crew members that each passenger close contacts with on average.
<b>c<sub>ww</sub></b>	The number of crew members that each crew member close contacts with on average.
<b>c<sub>wp</sub></b>	The number of passengers that each crew member close contacts with on average.
<b>μ</b>	The mobility (or disembarkation) rate.
<b>β<sub>1</sub></b>	The (out-of-room) infectious rate of asymptomatic people.
<b>β<sub>2</sub></b>	The (out-of-room) infectious rate of infectious people.
<b>β<sub>r1</sub></b>	The (in-the-room) infectious rate of asymptomatic people.
<b>β<sub>r2</sub></b>	The (in-the-room) infectious rate of infectious people.
<b>α<sub>1</sub></b>	The transformation rate from the exposed to be asymptomatic.
<b>α<sub>2</sub></b>	The transformation rate from the asymptomatic to the symptomatic.
<b>γ<sub>1</sub></b>	The isolate rate of asymptomatic people.
<b>γ<sub>2</sub></b>	The isolate rate of infectious people.

---

$$\begin{cases} \frac{dS}{dt} = -\mu S - \beta_1 A c \frac{S}{N} - \beta_2 I c \frac{S}{N} \\ \frac{dE}{dt} = -\mu E + \beta_1 A c \frac{S}{N} + \beta_2 I c \frac{S}{N} - \alpha_1 E \\ \frac{dA}{dt} = -\mu A + \alpha_1 E - \alpha_2 A - \gamma_1 A \\ \frac{dI}{dt} = -\mu I + \alpha_2 A - \gamma_2 I \\ \frac{dJ}{dt} = \gamma_1 A + \gamma_2 I \end{cases}$$

The basic model assumes that all people have the same probability of infection after close contact with infection sources. The infectious rate of asymptomatic (A) people  $\beta_1$  is different from infectious (I) people's  $\beta_2$ , and there is movement  $\mu$  during the outbreak. A susceptible (S) person may be infected after close contact with an infection resource (an asymptomatic (A) or infectious (I) person) and becomes exposed (E). He is non-infectious in the first stage during the incubation period ( $1/\alpha_1$ ). An exposed (E) person becomes asymptomatic (A) after  $1/\alpha_1$  days, and he is able to infect susceptible (S) people in the second stage during incubation period  $1/\alpha_2$ .  $1/\alpha_2$  days later, he becomes infectious (I) and develops symptoms. We supposed that the nucleic acid results of asymptomatic (A) and infectious (I) people are positive, so they have isolate rates  $\gamma_1$  and  $\gamma_2$ , respectively. The model can be generated into other forms when fitting, and the derivation is well-formatted in Appendix 6.

### 2.3. The basic reproduction number under anthropogenic intervention

In combination with the basic reproduction number first introduced by Ross (Ross, 1910) and the situation on the cruise ship 'Diamond Princess', patients were isolated from the population before the end of the infection. We redefine the basic reproduction number in our model as:

$$R_0 = \frac{\sum_{i=1}^{N_{AI}} \beta c[i] T[i]}{N_{AI}}$$

where  $N_{AI}$  is the total number of infected patients,  $\beta[i]$ ,  $c[i]$ ,  $T[i]$  are the infectious rate, the number of susceptible close contacts, and the duration of staying on board after being affected by the patient  $i$ , respectively. Moreover,  $T$  of asymptomatic patients has two possible calculations. If the asymptomatic patient was isolated during his incubation period,  $T$  equals his isolated date minus the estimated beginning date of his infectious incubation period. Meanwhile,  $T$  equals the infectious incubation period for his asymptomatic stages if the patient was isolated after symptoms.

**Table 3**  
The meaning of subscripts of notations.

2	The people living in the double room.
3	The people living in the triple room.
B	The people are onboard.
ci	The change in the number of people takes place in the room.
co	The change in the number of people takes place outside the room.
d	The people disembark.
j	The people are isolated.
p	Passengers.
w	The crew.
r	The people are inside the room.
Sr	The people whose roommate is susceptible in a double room.
Er	The people whose roommate is exposed in a double room.
SSr	The people whose roommates are both susceptible in a triple room.
SEr	The people whose roommates are susceptible and exposed respectively in a triple room.
EEr	The people whose roommates are both exposed in a triple room.

#### 2.4. A Bayesian estimation method

Estimation of the implementation of epidemic models is based on the Bayesian framework. Details explanation and the pseudo-code can be found in [Appendix 2](#) (see [Table 3](#)).

### 3. Results

This section shows the estimation results and interpretations are explored in detail. The fitted parameters are listed in [Tables 4 and 5](#).

The number of passengers that each crew member close contacts with before and after quarantining is dynamic throughout. It depends on the number of passengers ( $N_p$ ) and crew members ( $N_c$ ) on board and the number of crews that each passenger had close contact with ( $c_{pw}$ ) at time  $t$ .

**Table 4**  
The descriptions of parameters.

Parameter	Description
$\alpha_1$	The transformation rate from the exposed to be the asymptomatic
$\alpha_2$	The transformation rate from the asymptomatic to be the symptomatic
$\beta_1$	The (out-of-room) infectious rate of the asymptomatic people
$\beta_2$	The (out-of-room) infectious rate of the infectious people
$\beta_{r1}$	The infectious rate (in the room) of the asymptomatic people
$\beta_{r2}$	The infectious rate (in the room) of the infectious people
$c_{pp1}$	The number of passengers that each passenger close contacts with before quarantining
$c_{pp2}$	The number of passengers that each passenger close contacts with after quarantining
$c_{pw1}$	The number of the crew that each passenger close contacts with before quarantining
$c_{pw2}$	The number of the crew that each passenger close contacts with after quarantining
$c_{ww1}$	The number of the crew that each crew member close contacts with before quarantining
$c_{ww2}$	The number of the crew that each crew member close contacts with after quarantining
$\beta \cdot c$	The product of infectious rates and close contacts
CEd	Cumulative number of the exposed people disembarkation
$\rho(X,Y)$	The summary statistics, or the target error for the simulation method
M	The number of people infected inside room
$R_{0Ap1}$	The basic reproduction number of the asymptomatic passengers before quarantining
$R_{0Ap2}$	The basic reproduction number of the asymptomatic passengers after quarantining
$R_{0Aw1}$	The basic reproduction number of the asymptomatic crew before quarantining
$R_{0Aw2}$	The basic reproduction number of the asymptomatic crew after quarantining
$R_{0Ip1}$	The basic reproduction number of the infectious passengers before quarantining
$R_{0Ip2}$	The basic reproduction number of the infectious passengers after quarantining
$R_{0Iw1}$	The basic reproduction number of the infectious crew before quarantining
$R_{0Iw2}$	The basic reproduction number of the infectious crew after quarantining
$R_{0PatientO1}$	The basic reproduction number of the patient O before quarantining
$R_{0PatientO2}$	The basic reproduction number of the patient O after quarantining

**Table 5**  
The priors of parameters.

Parameters	Prior	Explanations
$\alpha_1$	1/U(1, 4)	Non-informative
$\alpha_2$	1/(U(4,14)-1/ $\alpha_1$ )	Derived from the official quarantine measure, a full quarantine period lasts up to 14 days
$\beta_1$	U(0.0115,0.4551)	Non-informative
$\beta_2$	U(0.0115,0.4551)	Non-informative
$\beta_{r1}$	U(0.0115,0.4551)	Non-informative
$\beta_{r2}$	U(0.0115,0.4551)	Non-informative
$c_{pp1}$	U(0,50)	Non-informative
$c_{pp2}$	U(0,1)	Limited activity
$c_{pw1}$	U(0,50)	Non-informative
$c_{pw2}$	U(0,1)	Limited activity
$c_{ww1}$	U(0,50)	Non-informative
$c_{ww2}$	U(0,1)	Medical protection

**Table 6**  
The descriptive statistics of parameters.

Type	Parameters	Mean	Maximum	Minimum	Median	Variance
$\alpha$	$\alpha_1$	0.3820	0.6725	0.2817	0.3766	0.0024
	$\alpha_2$	0.0917	0.1023	0.0812	0.0919	0.0000
$\beta$	$\beta_1$	0.0143	0.0347	0.0044	0.0141	0.0000
	$\beta_2$	0.0520	0.0971	0.0181	0.0523	0.0001
	$\beta_{r1}$	0.0631	0.2467	0.0102	0.0583	0.0007
	$\beta_{r2}$	0.4925	0.7160	0.1137	0.4963	0.0075
	$c$	$c_{pp1}$	48.0782	56.7553	21.1747	48.3549
	$c_{pp2}$	0.5076	1.0647	0.2036	0.4976	0.0171
	$c_{pw1}$	6.8513	8.3091	2.3675	6.9092	0.3485
	$c_{pw2}$	0.1219	0.3379	0.0007	0.1196	0.0026
	$c_{ww1}$	2.9598	8.4711	0.0023	2.8500	2.5916
	$c_{ww2}$	0.1803	1.4450	0.0002	0.1492	0.0231
$\beta \cdot c$	$\beta_1 \cdot c_{pp1}$	0.6812	1.0856	0.2241	0.6727	0.0143
	$\beta_1 \cdot c_{pw1}$	0.0975	0.1642	0.0311	0.0959	0.0004
	$\beta_1 \cdot c_{ww1}$	0.0416	0.1461	0.0000	0.0393	0.0005
	$\beta_2 \cdot c_{pp1}$	2.4955	4.2872	0.8774	2.5189	0.3331
	$\beta_2 \cdot c_{pw1}$	0.3562	0.6616	0.1250	0.3589	0.0075
	$\beta_2 \cdot c_{ww1}$	0.1534	0.5601	0.0002	0.1435	0.0085
	$\beta_1 \cdot c_{pp2}$	0.0072	0.0212	0.0027	0.0069	0.0000
	$\beta_1 \cdot c_{pw2}$	0.0017	0.0054	0.0000	0.0016	0.0000
	$\beta_1 \cdot c_{ww2}$	0.0025	0.0182	0.0000	0.0021	0.0000
	$\beta_2 \cdot c_{pp2}$	0.0261	0.0753	0.0080	0.0252	0.0001
	$\beta_2 \cdot c_{pw2}$	0.0062	0.0177	0.0000	0.0061	0.0000
	$\beta_2 \cdot c_{ww2}$	0.0092	0.0839	0.0000	0.0075	0.0001
	<b>cumulative</b>	<b>CEd</b>	31.3446	49.2728	14.0374	31.2540
<b>M</b>		297.7655	352.3853	213.2619	297.8613	306.4008
<b>discrepancy</b>	$\rho(X,Y)$	18.7126	18.9994	18.1945	18.7316	0.0357
	<b>R<sub>0</sub></b>	<b>R<sub>0Ap1</sub></b>	2.0503	3.1666	0.7855	2.0371
	<b>R<sub>0Ap2</sub></b>	0.2039	0.3842	0.0611	0.2001	0.0017
	<b>R<sub>0Aw1</sub></b>	0.4986	0.7763	0.2319	0.4968	0.0048
	<b>R<sub>0Aw2</sub></b>	0.1630	0.2829	0.0504	0.1604	0.0011
	<b>R<sub>0Ip1</sub></b>	8.5524	14.3709	3.1933	8.6342	3.3652
	<b>R<sub>0Ip2</sub></b>	0.3652	0.5637	0.1990	0.3686	0.0025
	<b>R<sub>0Iw1</sub></b>	2.1248	3.3162	0.9184	2.1337	0.1372
	<b>R<sub>0Iw2</sub></b>	0.3553	0.6108	0.1589	0.3587	0.0038
	<b>R<sub>0PatientO1</sub></b>	2.3349	3.7372	0.7651	2.3089	0.1729
	<b>R<sub>0PatientO2</sub></b>	5.6942	9.8813	2.0017	5.7512	1.7421

$$c_{wp}[t] = \frac{N_p[t]c_{pw}[t]}{N_c[t]}$$

The summary statistics  $\rho(X,Y)$  are calculated by the summation of the difference between the actually and simulated accumulative reported cases, the number of infectious cases, the number of exposed people, and the number of asymptomatic

people on board on the day before all the people disembarked. The tolerance set  $\varepsilon$  was set at  $\{300, 150, 100, 60, 35, 25, 19\}$ . Our target is to find 1000 groups of parameters for the SEAIJ model which satisfy  $\rho(X, Y) \leq 19$ , and the results are shown in Table 6.

The susceptible people are infected after close contact with an asymptomatic person outside the room with an average probability of 0.0143, infectious people outside room 0.0520, asymptomatic people inside room 0.0631, and infectious people inside rooms with the average probability of 0.4925.

Once the susceptible people are infected, they can not infect the susceptible people in  $\frac{1}{0.3820} \approx 2.6178$  days on average. They can infect the susceptible people in  $\frac{1}{0.0917} \approx 10.9051$  days before onset. After around  $2.6178 + 10.9051 = 13.5229$ -day incubation period, people developed symptoms. The infectious rates and the periods are based on the close contact population.

Before quarantining, the number of passengers who one passenger close contacts with is 48.0782 on average. On average, the number of crew members that one passenger close contacts with is 6.8513. The number of crew members that one crew member close contacts with is 2.9598 on average. The number of passengers that one crew member close contact with is calculated by the equation and shown in Fig. 2. The mean value is around 16.

After quarantine, the number of passengers that one passenger close contacts with is 0.5076 on average. The number of crew members that one passenger close contacts with is 0.1219 on average. The number of crew members that one crew close contacts with is 0.1803 on average. The number of passengers that one crew close contact with is around 0.28 (Fig. 2).

Given the same daily number of infected people, the more people infected outside the room, the less infected inside the room.  $\beta \cdot c$  represents infectious efficiency outside the room. It is the maximum number of susceptible people infected by an

**Table 7a**  
Comparison to other studies.

Different Areas	Rocklöv et al. (Rocklöv et al., 2020a, 2020b)	Our study
<b>Publish Date</b>	<ul style="list-style-type: none"> <li>Feb. 2020</li> </ul>	
<b>Epidemic model</b>	<ul style="list-style-type: none"> <li>SEIR</li> </ul>	<ul style="list-style-type: none"> <li>SEAIJ</li> </ul>
<b>Inference Method</b>		<ul style="list-style-type: none"> <li>Approximate Bayesian method</li> <li>Population Monte Carlo</li> </ul>
<b>Heterogeneities</b>	<ul style="list-style-type: none"> <li>Identities</li> <li>Transmission schemes</li> <li>Mixed Structures</li> </ul>	<ul style="list-style-type: none"> <li>Identities</li> <li>Transmission schemes</li> <li>Infection sources</li> <li>Outbreak stages</li> <li>Mixed Structures</li> </ul>
<b>Transmission Schemes</b>	<ul style="list-style-type: none"> <li>Protected vs. Nonprotected</li> </ul>	<ul style="list-style-type: none"> <li>Protected vs. Nonprotected</li> <li>Close contact</li> </ul>
<b>Infection sources</b>	<ul style="list-style-type: none"> <li>Infectious patients</li> </ul>	<ul style="list-style-type: none"> <li>Inside vs. outside the room</li> <li>Infectious patients</li> <li>Asymptomatic patients (covered presymptomatic)</li> </ul>
<b>Outbreak stages</b>	<ul style="list-style-type: none"> <li>Before isolation</li> <li>After isolation</li> </ul>	<ul style="list-style-type: none"> <li>Before isolation</li> <li>After isolation</li> <li>Duration of disembarkation</li> </ul>
<b>Data period</b>	<ul style="list-style-type: none"> <li>Jan. 21st – Feb. 19th</li> </ul>	<ul style="list-style-type: none"> <li>After duration of disembarkation</li> <li>Jan. 20th - Mar. 16th</li> </ul>
<b>Fixed parameters</b>	<ul style="list-style-type: none"> <li>transmissibility and contact rate (population, crew, passengers)</li> <li>Incubation period</li> <li>Infectious period or time to removal</li> </ul>	
<b>Sampling Parameters</b>		<ul style="list-style-type: none"> <li>Number of close contact</li> <li>A,I infectious rates inside rooms</li> <li>A,I infectious rates outside rooms</li> <li>Non-infectious talent period</li> <li>Infectious talent period</li> </ul>
<b>Conclusions</b>	<ul style="list-style-type: none"> <li>Before isolation: <ul style="list-style-type: none"> <li><math>R_0</math>: 14.8</li> </ul> </li> <li>After isolation: <ul style="list-style-type: none"> <li><math>R_0</math>: 1.78</li> </ul> </li> <li>Throughout outbreak:</li> </ul>	<ul style="list-style-type: none"> <li>Before isolation: <ul style="list-style-type: none"> <li>Mean <math>R_{0Ap}</math>: 2.0503</li> <li>Mean <math>R_{0Aw}</math>: 0.4986</li> <li>Mean <math>R_{0Ip}</math>: 8.5524</li> <li>Mean <math>R_{0Iw}</math>: 2.1248</li> </ul> </li> <li>After isolation: <ul style="list-style-type: none"> <li>Mean <math>R_{0Ap}</math>: 0.2039</li> <li>Mean <math>R_{0Aw}</math>: 0.1630</li> <li>Mean <math>R_{0Ip}</math>: 0.3652</li> <li>Mean <math>R_{0Iw}</math>: 0.3553</li> </ul> </li> <li>Throughout outbreak: <ul style="list-style-type: none"> <li>l outside-the-room infectious rate: 0.0143</li> <li>I outside-the-room infectious rate: 0.0520</li> <li>Inside-the-room infectious rate: 0.0631</li> <li>I inside-the-room infectious rate: 0.4925</li> </ul> </li> </ul>

infected person per day. The difference of this product affects the difference of in-the-door infectious rate since we specify the number of people in a room.

There are 31.3446 exposed people disembarked on average. Averagely 297.7655 of 712 people are infected inside the room. The summary statistics  $\rho(X,Y)$  are small enough to fit the actual scenario. It is inefficient to find the parameters that make the  $\rho(X,Y)$  less than 18.

The basic reproduction number of asymptomatic passengers before quarantining is 2.0503 on average, which is 0.2039 after quarantining. The basic reproduction number of the infectious passengers before quarantining is 8.5524 on average, which is 0.3652 after quarantining.

The basic reproduction number of the asymptomatic crew before quarantining is 0.4986 on average, which is 0.1630 after quarantining. The basic reproduction number of the infectious crew before quarantining is 2.1248 on average, which is 0.3553 after quarantining.

The cumulative number of people infected by the original patient is 2.3349 on average before his symptoms occur, and which is 5.6942 after his symptoms occurred.

In general, the proposed model indicates several characteristics of the COVID-19 transmission within an enclosed space with an application in the 'Diamond Princess' dataset.

Firstly, the infectious rate of asymptomatic people is less than the infectious people if the transmission schemes are the same. It indicated that the in-room transmission is faster than the out-of-room transmission if the infection sources are the

**Table 7b**  
Comparison to other studies.

Different Areas	Nishiura (Rocklöv et al., 2020a, 2020b)	Our study
<b>Publish Date</b>	<ul style="list-style-type: none"> <li>Feb. 2020</li> </ul>	
<b>Epidemic model</b>	<ul style="list-style-type: none"> <li>Richard model</li> </ul>	<ul style="list-style-type: none"> <li>SEAIJ</li> </ul>
<b>Inference Method</b>		<ul style="list-style-type: none"> <li>Approximate Bayesian method</li> <li>Population Monte Carlo</li> </ul>
<b>Heterogeneities</b>	<ul style="list-style-type: none"> <li>Identities</li> <li>Transmission schemes</li> </ul>	<ul style="list-style-type: none"> <li>Identities</li> <li>Transmission schemes</li> <li>Infection sources</li> <li>Outbreak stages</li> <li>Mixed Structures</li> <li>Protected vs. Nonprotected</li> <li>Close contact</li> <li>Inside vs. outside the room</li> <li>Symptomatic patients</li> <li>Asymptomatic patients (covered presymptomatic)</li> </ul>
<b>Transmission Schemes</b>	<ul style="list-style-type: none"> <li>Protected vs. Nonprotected</li> </ul>	<ul style="list-style-type: none"> <li>Protected vs. Nonprotected</li> <li>Close contact</li> <li>Inside vs. outside the room</li> </ul>
<b>Infection sources</b>	<ul style="list-style-type: none"> <li>Infectious patients</li> </ul>	<ul style="list-style-type: none"> <li>Symptomatic patients</li> <li>Asymptomatic patients (covered presymptomatic)</li> </ul>
<b>Outbreak stages</b>	<ul style="list-style-type: none"> <li>Before isolation</li> <li>After isolation</li> </ul>	<ul style="list-style-type: none"> <li>Before isolation</li> <li>After isolation</li> <li>Duration of disembarkation</li> <li>After duration of disembarkation</li> </ul>
<b>Data period</b>	<ul style="list-style-type: none"> <li>Jan. 20th – Feb. 19th</li> </ul>	<ul style="list-style-type: none"> <li>Jan. 20th - Mar. 16th</li> </ul>
<b>Fixed parameters</b>		
<b>Sampling Parameters</b>	<ul style="list-style-type: none"> <li>Incubation period</li> </ul>	<ul style="list-style-type: none"> <li>Number of close contact</li> <li>A,I infectious rates inside rooms</li> <li>A,I infectious rates outside rooms</li> <li>Non-infectious talent period</li> <li>Infectious talent period</li> </ul>
<b>Conclusions</b>	<ul style="list-style-type: none"> <li>Before isolation: <ul style="list-style-type: none"> <li>Peak time of infection: Feb. 2nd – Feb. 4th</li> </ul> </li> <li>After isolation: <ul style="list-style-type: none"> <li>Incidence abruptly declined</li> <li>Daily 0.98 passenger infected</li> <li>The cumulative incidence (as of Feb. 24th): <ul style="list-style-type: none"> <li>102 passengers with close contact</li> <li>47 passengers without close contact</li> <li>48 crew members</li> </ul> </li> <li>Throughout outbreak:</li> </ul> </li> </ul>	<ul style="list-style-type: none"> <li>Before isolation: <ul style="list-style-type: none"> <li>Mean <math>R_{0Ap}</math>: 2.0503</li> <li>Mean <math>R_{0Aw}</math>: 0.4986</li> <li>Mean <math>R_{0Ip}</math>: 8.5524</li> <li>Mean <math>R_{0Iw}</math>: 2.1248</li> </ul> </li> <li>After isolation: <ul style="list-style-type: none"> <li>Mean <math>R_{0Ap}</math>: 0.2039</li> <li>Mean <math>R_{0Aw}</math>: 0.1630</li> <li>Mean <math>R_{0Ip}</math>: 0.3652</li> <li>Mean <math>R_{0Iw}</math>: 0.3553</li> </ul> </li> <li>Throughout outbreak: <ul style="list-style-type: none"> <li>Outside-the-room infectious rate: 0.0143</li> <li>I outside-the-room infectious rate: 0.0520</li> <li>Inside-the-room infectious rate: 0.0631</li> <li>I inside-the-room infectious rate: 0.4925</li> </ul> </li> </ul>

same. However, the asymptomatic people inside the room are more contagious than the infectious people outside the room.

Secondly, people without symptoms transmit COVID-19 with infectious rate 0.0044–0.0143 around 10.9 days during the incubation period. If the daily number of close contacts is 21.2–56.8, an asymptomatic patient is expected to be able to infect 2.4–11.8 people. That means it is necessary to find asymptomatic infected people and the people who close contact with infection sources.

Thirdly, the cumulative number of exposed people disembarking averages around 31.3. Since around 71 people's nucleic acid results were positive after disembarkation, 31.3 is too small. One of the main reasons was that asymptomatic people infected some people during their disembarkation. The other main reason was that we assumed the people permitted to disembark were randomly picked, which were actually specified.

Fourthly, around 298 of 712 people are infected inside rooms. We concluded that out-of-room transmission is the main scheme for the COVID-19 outbreak based on the percentage of people infected inside the room. However, as the number of people in a room increases, the inside-room transmission may become the main scheme for transmission due to the higher inside-the-room infectious rate. To keep the air flowing in the room and decrease the number of people living in one room is also helpful to avoid the COVID-19 outbreak.

Fifthly, the infected passengers infected more susceptible people than the infected crew members. We assumed that asymptomatic people have the same infectious rates, and infectious people have the same infectious rates. Then, the number of close contacts becomes the variable that affects the number of people that passengers and the crew infected. In experiments, the number of close contacts of passengers is greater than that of crew members, so we conclude that the infected passengers were more likely to infect susceptible people outside rooms.

**Table 7c**  
Comparison to other studies.

Different Areas	Liu et al. (Liu et al., 2020b)	Our study
<b>Publish Date</b>	<ul style="list-style-type: none"> <li>• Apr. 2020</li> </ul>	<ul style="list-style-type: none"> <li>• SEAIJ</li> </ul>
<b>Epidemic model</b>	<ul style="list-style-type: none"> <li>• SIR</li> </ul>	<ul style="list-style-type: none"> <li>• Approximate Bayesian method</li> </ul>
<b>Inference Method</b>	<ul style="list-style-type: none"> <li>• Bayesian framework</li> <li>• Metropolis-Hastings sampling</li> </ul>	<ul style="list-style-type: none"> <li>• Population Monte Carlo</li> </ul>
<b>Heterogeneities</b>	<ul style="list-style-type: none"> <li>• Identities</li> <li>• Transmission schemes</li> <li>• Infection sources</li> <li>• Outbreak stages</li> </ul>	<ul style="list-style-type: none"> <li>• Identities</li> <li>• Transmission schemes</li> <li>• Infection sources</li> <li>• Outbreak stages</li> <li>• Mixed Structures</li> </ul>
<b>Transmission Schemes</b>	<ul style="list-style-type: none"> <li>• Protected vs. Nonprotected</li> <li>• Contact vs. Airborne</li> </ul>	<ul style="list-style-type: none"> <li>• Protected vs. Nonprotected</li> <li>• Close contact</li> <li>• Inside vs. outside the room</li> </ul>
<b>Infection sources</b>	<ul style="list-style-type: none"> <li>• Infectious patients</li> <li>• Airborne</li> </ul>	<ul style="list-style-type: none"> <li>• Symptomatic patients</li> <li>• Asymptomatic patients (covered presymptomatic)</li> </ul>
<b>Outbreak stages</b>	<ul style="list-style-type: none"> <li>• Before isolation</li> <li>• After isolation</li> </ul>	<ul style="list-style-type: none"> <li>• Before isolation</li> <li>• After isolation</li> <li>• Duration of disembarkation</li> <li>• After duration of disembarkation</li> </ul>
<b>Data period</b>	<ul style="list-style-type: none"> <li>• Jan. 20th - Feb. 19th</li> </ul>	<ul style="list-style-type: none"> <li>• Jan. 20th - Mar. 16th</li> </ul>
<b>Fixed parameters</b>	<ul style="list-style-type: none"> <li>• Infected period</li> <li>• Viable period of virus in the air</li> </ul>	
<b>Sampling Parameters</b>	<ul style="list-style-type: none"> <li>• Number of close contact</li> <li>• I infectious rate</li> <li>• Infectious rate of airborne</li> </ul>	<ul style="list-style-type: none"> <li>• Number of close contact</li> <li>• A,I infectious rates inside rooms</li> <li>• A,I infectious rates outside rooms</li> <li>• Non-infectious talent period</li> <li>• Infectious talent period</li> </ul>
<b>Conclusions</b>	<ul style="list-style-type: none"> <li>• <b>Before isolation:</b></li> <li>• Mean <math>R_0</math>: 6.94</li> <li>• I infectious rate: 0.026</li> <li>• <b>After isolation:</b></li> <li>• Mean <math>R_0</math>: 0.2</li> <li>• I infectious rate: 0.0007</li> <li>• Throughout outbreak:</li> </ul>	<ul style="list-style-type: none"> <li>• <b>Before isolation:</b></li> <li>• Mean <math>R_{0Ap}</math>: 2.0503</li> <li>• Mean <math>R_{0Aw}</math>: 0.4986</li> <li>• Mean <math>R_{0Ip}</math>: 8.5524</li> <li>• Mean <math>R_{0Iw}</math>: 2.1248</li> <li>• <b>After isolation:</b></li> <li>• Mean <math>R_{0Ap}</math>: 0.2039</li> <li>• Mean <math>R_{0Aw}</math>: 0.1630</li> <li>• Mean <math>R_{0Ip}</math>: 0.3652</li> <li>• Mean <math>R_{0Iw}</math>: 0.3553</li> <li>• Throughout outbreak:</li> <li>• Outside-the-room infectious rate: 0.0143</li> <li>• I outside-the-room infectious rate: 0.0520</li> <li>• Inside-the-room infectious rate: 0.0631</li> <li>• I inside-the-room infectious rate: 0.4925</li> </ul>



Lastly, the original patient infected more susceptible people during his onset period than during his incubation period. However, he was asymptomatic in 3 days and symptomatic in 2 days on the cruise ship.

#### 4. Discussion

There are quite a few works on mathematical models to fit COVID-19 outbreak data on the cruise ship 'Diamond Princess' and a comparison is prepared. Table 7 shows the differences of our model with these six models ((Emery et al., 2020), (Huang et al., 2021), (Liu et al., 2020b), (Rocklöv et al., 2020a, 2020b), (Rocklöv et al., 2020a, 2020b), (Morton et al., 2021)) in eleven areas.

Some limitations should be noted in the methodology. For example, the data we used were not from a random sample. Since only symptomatic cases were investigated during the early stage of the quarantine, it is possible that asymptomatic cases were missed out, which would affect the overall proportion of patients who tested positive (Rocklöv et al., 2020a, 2020b). In addition, since a majority of the passengers were older adults and it was unclear if older adults would develop more symptoms due to the underlying chronic diseases, including diabetes and cardiovascular disease (CVD), our study might underestimate the number of individuals who develop symptoms. Therefore, more detailed data regarding the passengers' health status, including the comorbidities, would improve the construction of our model.

**Table 7d**  
Comparison to other studies.

Different Areas	Emery et al. (Emery et al., 2020)	Our study
<b>Publish Date</b>	<ul style="list-style-type: none"> <li>• Aug. 2020</li> </ul>	
<b>Epidemic model</b>	<ul style="list-style-type: none"> <li>• SEPAIR</li> </ul>	<ul style="list-style-type: none"> <li>• SEAIJ</li> </ul>
<b>Inference Method</b>	<ul style="list-style-type: none"> <li>• Bayesian framework</li> <li>• Markov Chain Monte Carlo</li> </ul>	<ul style="list-style-type: none"> <li>• Approximate Bayesian method</li> <li>• Population Monte Carlo</li> </ul>
<b>Heterogeneities</b>	<ul style="list-style-type: none"> <li>• Identities</li> <li>• Transmission schemes</li> <li>• Infection sources</li> <li>• Outbreak stages</li> </ul>	<ul style="list-style-type: none"> <li>• Identities</li> <li>• Transmission schemes</li> <li>• Infection sources</li> <li>• Outbreak stages</li> <li>• Mixed Structures</li> </ul>
<b>Transmission Schemes</b>	<ul style="list-style-type: none"> <li>• Protected vs. Nonprotected</li> <li>• Close contact</li> </ul>	<ul style="list-style-type: none"> <li>• Protected vs. Nonprotected</li> <li>• Close contact</li> <li>• Inside vs. outside the room</li> </ul>
<b>Infection sources</b>	<ul style="list-style-type: none"> <li>• Infectious patients</li> <li>• Asymptomatic patients</li> <li>• Presymptomatic patients</li> </ul>	<ul style="list-style-type: none"> <li>• Symptomatic patients</li> <li>• Asymptomatic patients (covered presymptomatic)</li> </ul>
<b>Outbreak stages</b>	<ul style="list-style-type: none"> <li>• Before isolation</li> <li>• After isolation</li> </ul>	<ul style="list-style-type: none"> <li>• Before isolation</li> <li>• After isolation</li> <li>• Duration of disembarkation</li> <li>• After duration of disembarkation</li> </ul>
<b>Data period</b>	<ul style="list-style-type: none"> <li>• Jan. 20th - Feb. 20th</li> </ul>	<ul style="list-style-type: none"> <li>• Jan. 20th - Mar. 16th</li> </ul>
<b>Fixed parameters</b>	<ul style="list-style-type: none"> <li>• Talent period</li> <li>• Asymptomatic period</li> <li>• Pre-symptomatic period</li> <li>• Symptomatic period</li> </ul>	
<b>Sampling Parameters</b>	<ul style="list-style-type: none"> <li>• Number of close contact</li> <li>• P,A,I infectious rates</li> <li>• Percentage of A patients</li> </ul>	<ul style="list-style-type: none"> <li>• Number of close contact</li> <li>• A,I infectious rates inside rooms</li> <li>• A,I infectious rates outside rooms</li> <li>• Non-infectious talent period</li> <li>• Infectious talent period</li> </ul>
<b>Conclusions</b>	<ul style="list-style-type: none"> <li>• Before isolation:</li> <li>• <math>R_0</math> range: 6.7–10.9 depends on percentages of A</li> <li>• After isolation:</li> <li>• Throughout outbreak:</li> </ul>	<ul style="list-style-type: none"> <li>• Before isolation:</li> <li>• Mean <math>R_{0Ap}</math>: 2.0503</li> <li>• Mean <math>R_{0Aw}</math>: 0.4986</li> <li>• Mean <math>R_{0Ip}</math>: 8.5524</li> <li>• Mean <math>R_{0Iw}</math>: 2.1248</li> <li>• After isolation:</li> <li>• Mean <math>R_{0Ap}</math>: 0.2039</li> <li>• Mean <math>R_{0Aw}</math>: 0.1630</li> <li>• Mean <math>R_{0Ip}</math>: 0.3652</li> <li>• Mean <math>R_{0Iw}</math>: 0.3553</li> <li>• Throughout outbreak:</li> <li>• Outside-the-room infectious rate: 0.0143</li> <li>• I outside-the-room infectious rate: 0.0520</li> <li>• Inside-the-room infectious rate: 0.0631</li> <li>• I inside-the-room infectious rate: 0.4925</li> </ul>

**Table 7e**  
Comparison to other studies.

Different Areas	Lai CC. et al. (Morton et al., 2021)	Our study
<b>Publish Date</b>	<ul style="list-style-type: none"> <li>Jan. 2021</li> </ul>	
<b>Epidemic model</b>	<ul style="list-style-type: none"> <li>SEIR</li> </ul>	<ul style="list-style-type: none"> <li>SEAIJ</li> </ul>
<b>Inference Method</b>	<ul style="list-style-type: none"> <li>Deterministic</li> <li>Bayesian Markov Chain Monte Carlo</li> <li>Likelihood theory</li> </ul>	<ul style="list-style-type: none"> <li>Approximate Bayesian method</li> <li>Population Monte Carlo</li> </ul>
<b>Heterogeneities</b>	<ul style="list-style-type: none"> <li>Identities</li> <li>Transmission schemes</li> <li>Mixed Structure</li> </ul>	<ul style="list-style-type: none"> <li>Identities</li> <li>Transmission schemes</li> <li>Infection sources</li> <li>Outbreak stages</li> <li>Mixed Structures</li> <li>Protected vs. Nonprotected</li> <li>Close contact</li> <li>Inside vs. outside the room</li> <li>Symptomatic patients</li> <li>Asymptomatic patients (covered presymptomatic)</li> </ul>
<b>Transmission Schemes</b>	<ul style="list-style-type: none"> <li>within-deck vs. between-deck transmission</li> </ul>	<ul style="list-style-type: none"> <li>Before isolation</li> <li>After isolation</li> <li>Duration of disembarkation</li> <li>After duration of disembarkation</li> </ul>
<b>Infection sources</b>	<ul style="list-style-type: none"> <li>Infectious patients</li> </ul>	
<b>Outbreak stages</b>	<ul style="list-style-type: none"> <li>Before isolation (Jan. 20th – Feb. 4th)</li> <li>Early period of daily symptom-reported (Feb.5- Feb. 10th)</li> <li>Before systemic test (Feb. 11th- Feb. 13th)</li> <li>Before the evacuation of passengers from USA (Feb. 14th- Feb. 16th)</li> <li>Before the duration of disembarkation (Feb. 17th – Feb. 19th)</li> </ul>	<ul style="list-style-type: none"> <li>Jan. 20th - Mar. 16th</li> </ul>
<b>Data period</b>	<ul style="list-style-type: none"> <li>Jan. 20th – Feb. 19th</li> </ul>	
<b>Fixed parameters</b>	<ul style="list-style-type: none"> <li>incubation period (Deterministic, and Likelihood theory)</li> <li>recovery rate (Bayesian MCMC)</li> <li>transmission coefficients (Deterministic, Bayesian MCMC, and Likelihood theory)</li> </ul>	
<b>Sampling Parameters</b>	<ul style="list-style-type: none"> <li>incubation period (Bayesian MCMC)</li> <li>recovery rate (Bayesian MCMC)</li> <li>number of unknown infected status (Bayesian MCMC)</li> <li>the daily confirmed cases (Bayesian MCMC)</li> </ul>	<ul style="list-style-type: none"> <li>Number of close contact</li> <li>A,I infectious rates inside rooms</li> <li>A,I infectious rates outside rooms</li> <li>Non-infectious talent period</li> <li>Infectious talent period</li> </ul>
<b>Conclusions</b>	<ul style="list-style-type: none"> <li><b>Before isolation</b></li> <li><b>After isolation</b></li> <li><b>Throughout outbreak:</b> <ul style="list-style-type: none"> <li>Overall <math>R_0</math>: 5.70 (Bayesian MCMC)</li> <li>Overall <math>R_0</math>: 5.27 (Deterministic)</li> <li>Overall <math>R_0</math>: 5.43 (Maximum Likelihood)</li> <li><math>R_{0p}</math>: 5.18 (Bayesian MCMC)</li> <li><math>R_{0w}</math>: 2.46 (Bayesian MCMC)</li> </ul> </li> </ul>	<ul style="list-style-type: none"> <li><b>Before isolation:</b> <ul style="list-style-type: none"> <li>Mean <math>R_{0Ap}</math>: 2.0503</li> <li>Mean <math>R_{0Aw}</math>: 0.4986</li> <li>Mean <math>R_{0Ip}</math>: 8.5524</li> <li>Mean <math>R_{0Iw}</math>: 2.1248</li> </ul> </li> <li><b>After isolation:</b> <ul style="list-style-type: none"> <li>Mean <math>R_{0Ap}</math>: 0.2039</li> <li>Mean <math>R_{0Aw}</math>: 0.1630</li> <li>Mean <math>R_{0Ip}</math>: 0.3652</li> <li>Mean <math>R_{0Iw}</math>: 0.3553</li> </ul> </li> <li><b>Throughout outbreak:</b> <ul style="list-style-type: none"> <li>Outside-the-room infectious rate: 0.0143</li> <li>I outside-the-room infectious rate: 0.0520</li> <li>Inside-the-room infectious rate: 0.0631</li> <li>I inside-the-room infectious rate: 0.4925</li> </ul> </li> </ul>

With the increasing knowledge from clinical and epidemiological studies on the COVID-19 disease, the governments and policymakers can now design better mitigation strategies to control the spread of the COVID-19 pandemic. Some preventive measures, including the COVID-19 vaccination, social distancing, and wearing face masks, have been proven to control the pandemic successfully. Still, it is unclear about the timing and effectiveness of these measures. Also, the populations' response, psychological tolerance, and willingness to follow these preventive measures can vary significantly depending on how severe the COVID-19 pandemic affected the area (Morton et al., 2021). Therefore, the construction of a mathematical epidemic model can answer some critical questions that cannot be extrapolated from clinical and epidemiological studies. Under these models, the parameters can be incorporated, and the impact of the preventive measures on the COVID-19 community spread can be stimulated.

Moreover, these epidemic models can be used to predict the severity degree of the COVID-19 pandemic in populations under different risk exposures to the COVID-19. The findings from these models can then be used to generate informed predictions as to the most effective and sustainable mitigation strategies, including whether single or multiple preventive measures may offer the optimum protection while relaxing the mobility restriction in populations (Bertsimas et al., 2021). In addition, these models can be used to confirm the benefits of the implemented preventive measures by the government and policymakers.

**Table 7f**  
Comparison to other studies.

Different Areas	Huang, LS et al. (Huang et al., 2021)	Our study
<b>Publish Date</b>	<ul style="list-style-type: none"> <li>• Mar. 2021</li> </ul>	
<b>Epidemic model</b>	<ul style="list-style-type: none"> <li>• Chain binomial model</li> </ul>	<ul style="list-style-type: none"> <li>• SEAIJ</li> </ul>
<b>Inference Method</b>	<ul style="list-style-type: none"> <li>• Likelihood theory</li> </ul>	<ul style="list-style-type: none"> <li>• Approximate Bayesian method</li> <li>• Population Monte Carlo</li> </ul>
<b>Heterogeneities</b>	<ul style="list-style-type: none"> <li>• Identities</li> <li>• Transmission schemes</li> <li>• Infection sources</li> </ul>	<ul style="list-style-type: none"> <li>• Identities</li> <li>• Transmission schemes</li> <li>• Infection sources</li> <li>• Outbreak stages</li> <li>• Mixed Structures</li> </ul>
<b>Transmission Schemes</b>	<ul style="list-style-type: none"> <li>• Close contact</li> <li>• No quarantine vs. quarantine</li> </ul>	<ul style="list-style-type: none"> <li>• Protected vs. Nonprotected</li> <li>• Close contact</li> <li>• Inside vs. outside the room</li> </ul>
<b>Infection sources</b>	<ul style="list-style-type: none"> <li>• Infectious patients</li> <li>• Asymptomatic patients</li> </ul>	<ul style="list-style-type: none"> <li>• Symptomatic patients</li> <li>• Asymptomatic patients (covered presymptomatic)</li> </ul>
<b>Outbreak stages</b>	<ul style="list-style-type: none"> <li>• Before isolation</li> <li>• After isolation</li> </ul>	<ul style="list-style-type: none"> <li>• Before isolation</li> <li>• After isolation</li> <li>• Duration of disembarkation</li> <li>• After duration of disembarkation</li> </ul>
<b>Data period</b>	<ul style="list-style-type: none"> <li>• Jan. 21st – Feb. 19th</li> </ul>	<ul style="list-style-type: none"> <li>• Jan. 20th - Mar. 16th</li> </ul>
<b>Fixed parameters</b>	<ul style="list-style-type: none"> <li>• Serial interval</li> <li>• Proportion of infection that occurred in cabins</li> <li>• Asymptomatic ratio</li> <li>• Proportion of passengers and crew</li> </ul>	
<b>Sampling Parameters</b>	<ul style="list-style-type: none"> <li>• Transmission rate</li> </ul>	<ul style="list-style-type: none"> <li>• Number of close contact</li> <li>• A,I infectious rates inside rooms</li> <li>• A,I infectious rates outside rooms</li> <li>• Non-infectious talent period</li> <li>• Infectious talent period</li> </ul>
<b>Conclusions</b>	<ul style="list-style-type: none"> <li>• <b>Before isolation:</b> <ul style="list-style-type: none"> <li>• serial intervals:</li> <li>• 5 days <math>R_0</math>: 3.27</li> <li>• 6 days <math>R_0</math>: 3.78</li> </ul> </li> <li>• <b>After isolation:</b> <ul style="list-style-type: none"> <li>• serial intervals:</li> <li>• 5 days <math>R_{0p}</math>: 4.18</li> <li>• 6 days <math>R_{0p}</math>: 4.73</li> <li>• 5 days <math>R_{0w}</math>: 0.91</li> <li>• 6 days <math>R_{0w}</math>: 1.06</li> </ul> </li> <li>• <b>Throughout outbreak</b></li> </ul>	<ul style="list-style-type: none"> <li>• <b>Before isolation:</b> <ul style="list-style-type: none"> <li>• Mean <math>R_{0Ap}</math>: 2.0503</li> <li>• Mean <math>R_{0Aw}</math>: 0.4986</li> <li>• Mean <math>R_{0Ip}</math>: 8.5524</li> <li>• Mean <math>R_{0Iw}</math>: 2.1248</li> </ul> </li> <li>• <b>After isolation:</b> <ul style="list-style-type: none"> <li>• Mean <math>R_{0Ap}</math>: 0.2039</li> <li>• Mean <math>R_{0Aw}</math>: 0.1630</li> <li>• Mean <math>R_{0Ip}</math>: 0.3652</li> <li>• Mean <math>R_{0Iw}</math>: 0.3553</li> </ul> </li> <li>• <b>Throughout outbreak:</b> <ul style="list-style-type: none"> <li>• Outside-the-room infectious rate: 0.0143</li> <li>• I outside-the-room infectious rate: 0.0520</li> <li>• Inside-the-room infectious rate: 0.0631</li> <li>• I inside-the-room infectious rate: 0.4925</li> </ul> </li> </ul>

## 5. Conclusion

This study demonstrated how a data-driven epidemic model could model virus transmission within an enclosed space. We discussed the heterogeneity of the model in five aspects: identities, infection sources, transmission methods, size of rooms, and transmission stages. The basic reproduction number  $R_0$  for different infection sources is calculated, and an improved approximate Bayesian updating computation method is proposed. This work analyses the 'Diamond Princess' data in detail and provides some valuable management insights to the governments and policymakers for handling the COVID-19 pandemic spread.

## Appendix

### 1 Collected Data

We collect the daily disembarkation data (See Table A1) from the JMHLW and the cruise ship 'Diamond Princess' home page. We estimate that the unknown dates of disembarkation of around 600 people are Feb. 24th and Feb. 26th. The data period is from Jan. 20th to Mar. 16th and the unlisted dates are zeros. The same is true for the other tables under this section.

**Table A1**  
Daily Disembarkation without Isolation.

Date	Daily disembarkation without isolation	Comments
2020/2/1	22	
2020/2/14	11	
2020/2/17	400	Evacuation of U.S.
2020/2/19	450	Beginning of disembarkation
2020/2/20	544	
2020/2/21	461	
2020/2/22	15	
2020/2/23	230	
2020/2/24	320	Estimated Disembarkation
2020/2/25	18	
2020/2/26	321	Estimated Disembarkation
2020/2/27	92	
2020/3/1	131	End of disembarkation

The daily number of isolated passengers and crew members collected from JMHLW is shown in [Table A2](#). We estimate the double-counting occurs on Feb. 23rd.

**Table A2**  
Daily isolated passengers and crew members.

Date	Isolated passengers	Isolated crew members	Comments
2020/2/5	10	0	
2020/2/6	10	0	
2020/2/7	37	4	
2020/2/8	3	0	
2020/2/9	5	1	
2020/2/10	53	12	
2020/2/12	31	8	
2020/2/13	34	10	
2020/2/15	48	19	
2020/2/16	53	17	
2020/2/17	74	25	
2020/2/18	66	22	
2020/2/19	61	18	
2020/2/20	10	2	
2020/2/21	0	1	
2020/2/23	43	4	Estimated. Adjust due to double counting
2020/2/26	9	5	
2020/2/2	0	1	
2020/3/12	0	1	
2020/3/16	15	0	Adjust by JMHLW

The number of daily totally isolated people is calculated by the summation of daily isolated passengers and crew members (See [Table A3](#)).

**Table A3**  
Daily totally isolated people

Date	Isolated people	Cumulative isolated people	Comments
2020/2/5	10	10	
2020/2/6	10	20	
2020/2/7	41	61	
2020/2/8	3	64	
2020/2/9	6	70	
2020/2/10	65	135	
2020/2/12	39	174	
2020/2/13	44	218	
2020/2/15	67	285	
2020/2/16	70	355	
2020/2/17	99	454	
2020/2/18	88	542	
2020/2/19	79	621	
2020/2/20	12	633	
2020/2/21	1	634	

**Table A3** (continued)

Date	Isolated people	Cumulative isolated people	Comments
2020/2/23	47	681	Estimated. Adjust due to double counting
2020/2/26	14	695	
2020/2/2	1	696	
2020/3/12	1	697	
2020/3/16	15	712	Adjust by JMHLW

The daily number of isolated asymptomatic people collected from JMHLW is listed in [Table A4](#).

**Table A4**

Daily isolated asymptomatic people

Data	Asymptomatic People
2020/2/13	32
2020/2/15	38
2020/2/16	38
2020/2/17	70
2020/2/18	65
2020/2/19	68
2020/2/20	8
2020/2/26	12

2 Process of outbreak development

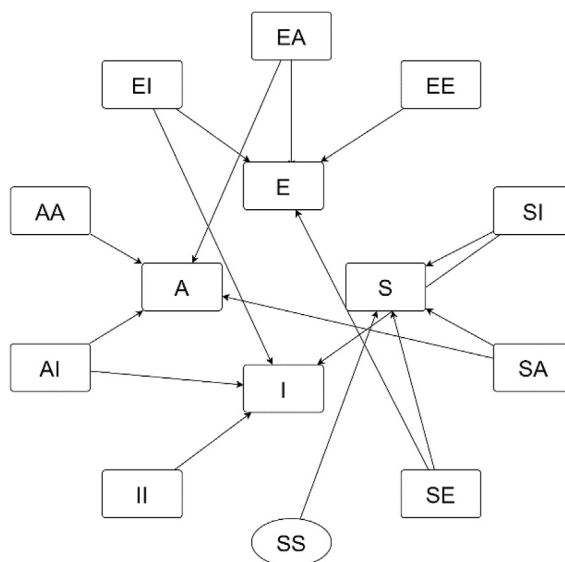

**Fig. A1.** The infectious change in double rooms due to disembarkation and isolation

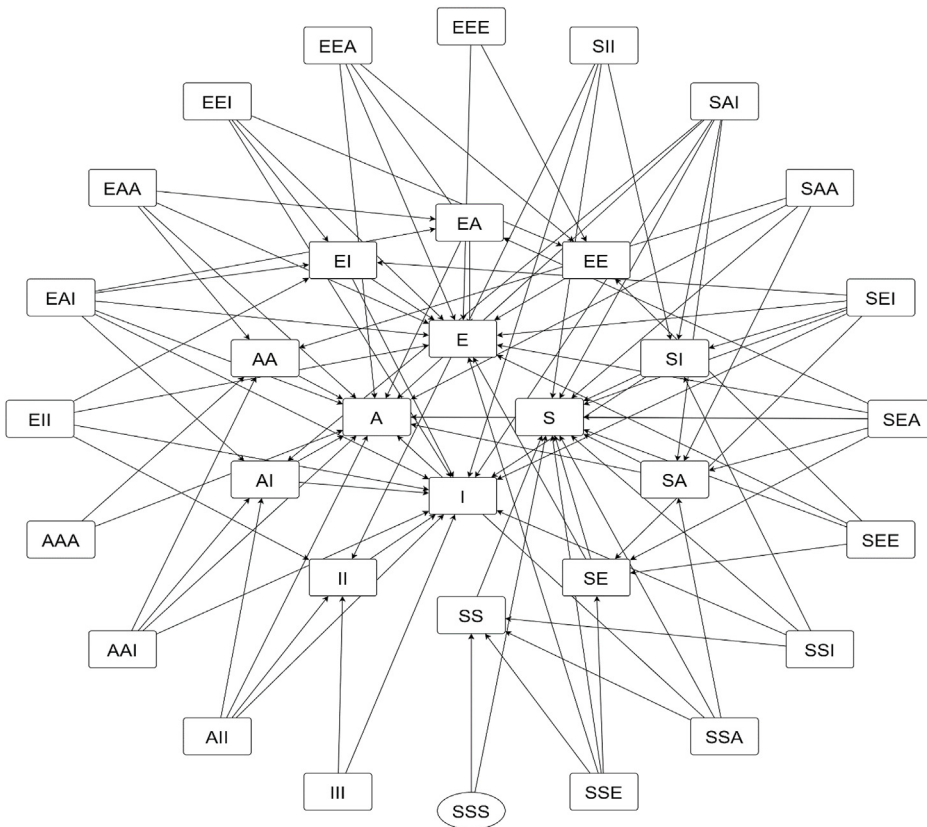

Fig. A2. The infectious change in triple rooms due to disembarkation and isolation

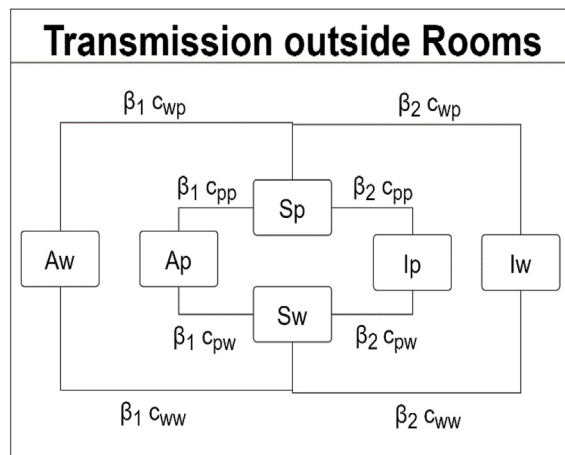

Fig. A3. Infection occurred outside rooms

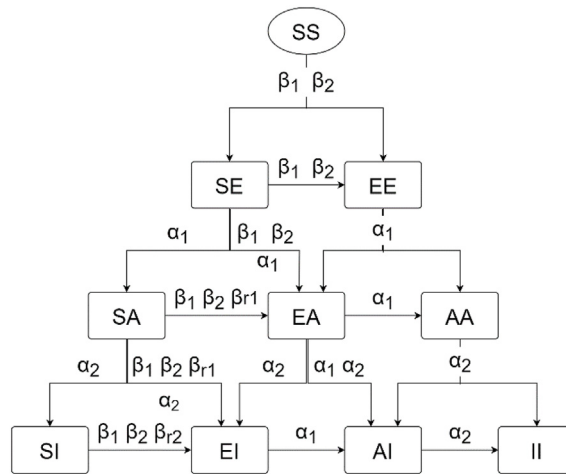

Fig. A4. The infectious change in double rooms after infection occurs

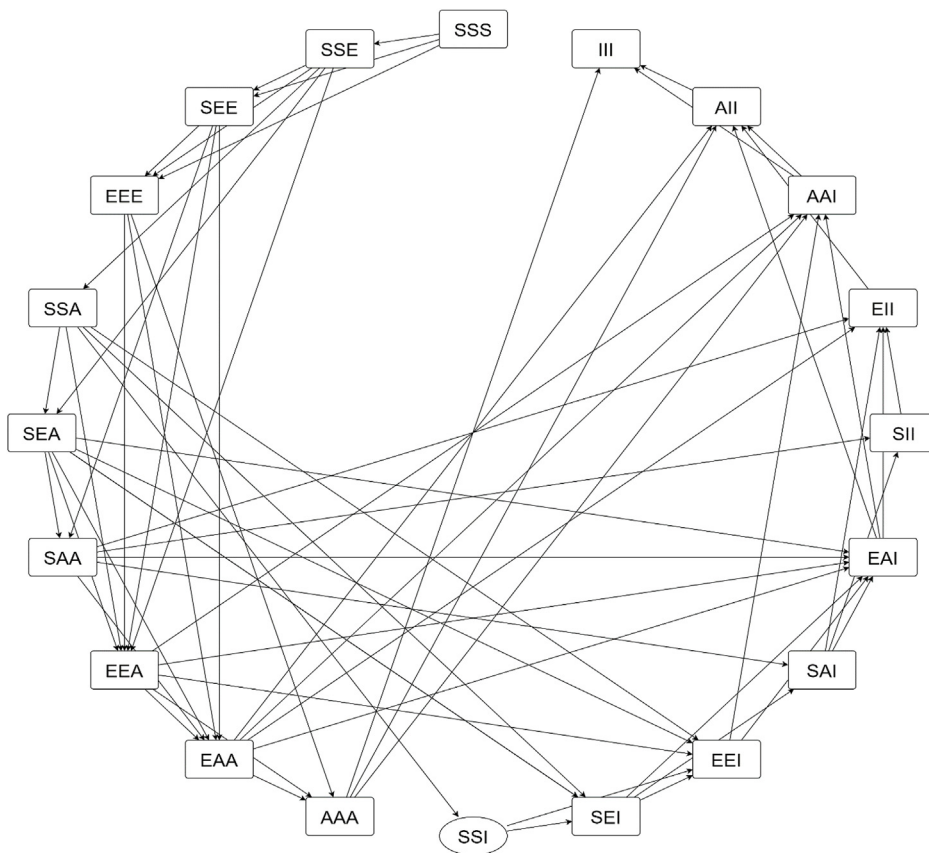

Fig. A5. The infectious change in triple rooms after infection occurs

### 3 Sampling Method

Following previous research, the implementation of epidemic models is based on the Bayesian framework. Inference in Bayesian statistics relies on the full posterior distribution defined as

$$\pi(\Theta|D) = \frac{p(D|\Theta)\pi(\Theta)}{p(D)},$$

where  $\theta$  denotes the vector of parameters in the model and  $D$  represents the observed data. The expression given in the above equation depends on the prior distribution  $\pi(\theta)$ , the likelihood function  $p(D|\theta)$ , and the marginal probability of the data  $p(D) = \int_{\Theta} p(D|\theta)\pi(\theta)d\theta$ .

There are mainly three advantages of employing Bayesian Inference. Firstly, the Bayesian framework, combined with the Markov Chain Monte Carlo method, makes it easier to obtain reliable intervals, providing a measure of uncertainty for the point estimate of parameters. Secondly, this can estimate model parameters directly and their functions, such as threshold parameters. Finally, it is easier to obtain multivariate information describing the relationship between different model parameters. This method is used in most applications to estimate the parameters of the underlying stochastic transmission model.

However, there are two requirements to compute or estimate the posterior distribution within the Bayesian framework. First, we must calculate the likelihood of the data, i.e., given a model with a set of parameters  $\theta$ , we must specify the probability of each observation in the sample. That is intractable in our model mentioned above. Second, we must supply a prior distribution for  $\theta$ . This prior distribution may depend on our previous understanding of likely values for  $\theta$ . Without knowledge of COVID-19 and the detailed information on the cruise ship, it is impossible to provide informative priors. These may make the Bayesian method ineffective for our model.

Hence, Approximate Bayesian Computation with Population Monte Carlo (ABC-PMC) without likelihood gets our attention. The idea of ABC-PMC is to generate a series of distributions for the model parameters that we are interested in, such that they evolve gradually from the initial distribution  $\mu_1$  towards the target distribution  $f_T$ . Usually, the prior distribution is chosen as  $\mu_1$ . Given the summary statistics  $S(\cdot)$ , the tolerance set  $\epsilon$ , and the distance function  $\rho$ , the ABC-PMC sampling method samples  $N$  particles  $\theta^{(1)}, \dots, \theta^{(N)}$  from the posterior  $f(\theta|\rho(S(x), S(x_0)) \leq \epsilon)$ , for observed data  $x_0$ , and for unknown parameter vector  $\theta \in \Theta$ . The meaning of the posterior is that the parameter  $\theta$  whose distance  $\rho$  between the summary statistic of observed data  $S(x_0)$  and the estimation data  $S(x)$  less than the tolerance  $\epsilon$  will be accepted. Standard importance sampling would then indicate how well each particle  $\theta_t^{(i)}$  adheres to  $f_{t+1}(\theta)$  by specifying the importance weight,  $w_t^{(i)} = f_{t+1}(\theta_t^{(i)})/f_t(\theta_t^{(i)})$ , it should receive in the entire population of  $N$  particles, for  $t = 1, 2, \dots, T$ , where  $f_1 \equiv \mu_1$ . That is, the ABC-PMC method proceeds by moving and reweighting the particles according to how well they adhere to each subsequent distribution,  $f_t$ . Since the sampling for  $t > 1$  employs the posteriors in  $t - 1$  as the priors, this method applies the principle of Bayesian updating.

The ABC-PMC method concerning only one parameter inference is inefficient when directly employed in our model because there are more than ten parameters in our model. Moreover, there are not only some products in some stages, for example, the calculation for  $S[t+1]$ , but also more than fifty loops so that the parameters in our model may recurse to the power of at least fifty. Therefore, our project makes some adjustments to this algorithm.

We define the parameters in the same particles as a group of parameters. At first, the parameters in the same group have the same weight in an iteration. This allows us to sample a random group of parameters in the next iteration, only to fine-tune the parameters in the same group to meet the convergence conditions. This is significantly faster than sampling the parameters separately and then multiplying them together.

Secondly, we use the ratio of  $w_{i,t} = w_{i,t-1} * \epsilon_{t+1} / \rho(X, Y)$  to replace the weight. The weight in the ABC-PMC algorithm concerns the ratio of the prior distribution for  $\theta_{i,t}$  and the sum of perturbed  $\theta_{i,t}$  individually, which is not an appropriate value for the parameters in the same group. Instead, the discrepancy for each iteration, which is determined by all the parameters in the same group, is the best choice. If the discrepancy of a group is closer to the tolerance of the next iteration, even less than the tolerance, we can say that it is nearer the target distribution, so it certainly has a higher weight. The ratio  $\epsilon_{t+1} / \rho(X, Y)$  will have a higher value when  $\rho(X, Y)$  is smaller. Since the weights consist of the information of the previous sampling, we can conclude that the normalised  $w_{i,T}$  is the probability of corresponding posterior given the observation data.

Thirdly, as there is a perturbation in each iteration, the posterior may be beyond the scope of the prior. That means even if the non-informative priors are not accurate enough, we can still get the posteriors that satisfy the tolerance condition.

Finally, we use some core values that represent the epidemic's status as the summary statistic function  $S(\cdot)$ . Previous research primarily uses one or more descriptive statistics as summary statistics, such as mean, variance, median, minimum, etc. Since the epidemic is a dynamic process, and there are usually omissions of cases reported, the descriptive statistics do not accurately describe the status of the epidemic. As a result, the final number of infectious patients, the number of people in each set on the last date that all the people left the cruise ship are chosen as summary statistics.

#### 4 Simulation Pseudo Code

1. Given data  $Y$  and model  $Y \sim \text{Model}(\theta)$ , a set of tolerance  $\epsilon$ , and priors distributions  $\pi(\theta)$ , where  $\theta$  is the parameter set of the model:
2. At iteration  $t = 1$ ,
3. for  $1 \leq i \leq N$  do
4. while  $\rho(X, Y) > \epsilon_1$  do
5. Sample parameter set  $\theta^*$  from the priors:  $\theta^* \sim \pi(\theta)$
6. Generate data  $X$  from the parameter set  $\theta^*$ :  $X \sim \text{Model}(\theta^*)$



7. Calculate discrepancy  $\rho(X,Y)$
8. end while
9. Set  $\theta_{i,1} \leftarrow \theta^*$
10. Set  $w_{i,1} \leftarrow \frac{\varepsilon_1}{\rho(X,Y)}$
11. end for
12. Normalised the weight  $w_{i,1}$  so that the summation of  $w_{i,1}$  is 1
13. Set  $\sigma_1^2 \leftarrow c \times \text{Var}(\theta_{1:N,1})$ , where  $c$  is a constant
14. At iteration  $t > 1$ ,
15. for  $2 \leq t \leq T$  do
16. for  $1 \leq i \leq N$  do
17. While  $\rho(X,Y) > \varepsilon_t$  do
18. Sample parameters set  $\theta^*$  from the previous iteration:  $\theta^* \sim \theta_{1:N,t-1}$  with probabilities  $w_{1:N,t-1}$
19. Perturb  $\theta^*$  by sampling  $\theta^{**} \sim N(\theta^*, \sigma_{t-1}^2)$
20. Generate data  $X$  from the parameter set  $\theta^{**}$ :  $X \sim \text{Model}(\theta^{**})$
21. Calculate discrepancy  $\rho(X,Y)$
22. end while
23. Set  $\theta_{i,t} \leftarrow \theta^{**}$
24. Set  $w_{i,t} \leftarrow w_{i,t-1} * \frac{\varepsilon_{t+1}}{\rho(X,Y)}$
25. end for
26. Set  $\sigma_t^2 \leftarrow c \times \text{Var}(\theta_{1:N,t})$ , where  $c$  is a constant
27. Normalised the weight  $w_{i,t}$  so that the summation of  $w_{i,t}$  is 1
28. end for

### 5 Details of the Epidemic Models

#### The homogeneous SEAIJ epidemic model on a cruise ship given daily data

Since the government usually reports the daily number of infectious cases, we rewrite the basic model as discrete schemes to fit the actual data. Moreover, we assume that the mobility of the population on a cruise ship was disembarkation only in our example, and every person has the same probability of disembarking at time  $t$ . The following results are expectations since there are probabilities or rates in all the formulas.

$$\begin{cases} S[t + 1] = S[t] - S_d[t] - \frac{\beta_1 A_b[t]c[t]S_b[t]}{N_b[t]} - \frac{\beta_2 I_b[t]c[t]S_b[t]}{N_b[t]} \\ E[t + 1] = E[t] - E_d[t] + \frac{\beta_1 A_b[t]c[t]S_b[t]}{N_b[t]} + \frac{\beta_2 I_b[t]c[t]S_b[t]}{N_b[t]} - \alpha_1 E_b[t] \\ A[t + 1] = A[t] - A_d[t] + \alpha_1 E_b[t] - \alpha_2 A_b[t] - \gamma_1 A_b[t] \\ I[t + 1] = I[t] - I_d[t] + \alpha_2 A_b[t] - \gamma_2 I_b[t] \\ J[t + 1] = J[t] + \gamma_1 A_b[t] + \gamma_2 I_b[t] \end{cases}$$

The people who had gotten off the boat do not affect the modeling of the people on the cruise ship. The number of disembarkations is subtracted in the model since our target is to study the outbreak on board. The number of susceptible people disembark at time  $t$  is  $S_d[t]$ , so the number of susceptible people on board at time  $t$  is  $S_b[t] = S[t] - S_d[t]$ . The notations of other compartments are similar.

#### The homogeneous SEAIJ epidemic model with the anthropogenic intervention on a cruise ship given daily data

The government isolates infectious cases from the population when an epidemic occurs. Since isolated rates under anthropogenic intervention are pretty different every day due to the effect of human intervention, we take the number of daily isolated cases as known data, represented as  $A_j[t]$  and  $I_j[t]$ , respectively. Therefore, the SEAIJ model is adjusted by:

$$\begin{cases} S[t + 1] = S[t] - S_d[t] - \frac{\beta_1 A_b[t]c[t]S_b[t]}{N_b[t]} - \frac{\beta_2 I_b[t]c[t]S_b[t]}{N_b[t]} \\ E[t + 1] = E[t] - E_d[t] + \frac{\beta_1 A_b[t]c[t]S_b[t]}{N_b[t]} + \frac{\beta_2 I_b[t]c[t]S_b[t]}{N_b[t]} - \alpha_1 E_b[t] \\ A[t + 1] = A[t] - A_d[t] + \alpha_1 E_b[t] - \alpha_2 A_b[t] - A_j[t] \\ I[t + 1] = I[t] - I_d[t] + \alpha_2 A_b[t] - I_j[t] \\ J[t + 1] = J[t] + A_j[t] + I_j[t] \end{cases}$$

The above homogeneous models assume that there is only one transmission scheme, which is not the case on a cruise ship. Infected people staying in the room are more contagious than those staying outside the room because the airflow inside the room is not as good. The following section discusses the scenario that contains 2 transmission schemes, in-the-room, and out-of-room transmissions.

*The heterogeneous SEAIJ epidemic model with different transmission schemes and the anthropogenic intervention on a cruise ship given daily data*

The number of susceptible people infected outside rooms at time t ( $S_{co}[t]$ ) is calculated by

$$S_{co}[t] = \frac{\beta_1 A_b[t]c[t]S_b[t]}{N_b[t]} + \frac{\beta_2 I_b[t]c[t]S_b[t]}{N_b[t]}$$

Supposedly there are only double rooms on the cruise ship. The inside-the-room transmission may occur when there is a susceptible person (S) and an infection source (an asymptomatic person (A) or an infectious person (I)) in the same room. Therefore, the number of susceptible people infected inside rooms at time t ( $S_{ci}[t]$ ) is calculated by

$$S_{ci}[t] = \beta_{r1}A_r[t] + \beta_{r2}I_r[t]$$

The population cannot increase since the cruise ship is an enclosed space. Then the number of susceptible people decreases by the disembarkation, the out-of-room, and in-the-room infections. The number of exposed people is inversely proportional to the number of the susceptible infected. Changes in other compartments (A, I, J) at time t are the same as the homogeneous model. In mathematics,

$$\begin{cases} S[t + 1] = S[t] - S_d[t] - S_{co}[t] - S_{ci}[t] \\ E[t + 1] = E[t] - E_d[t] + S_{co}[t] + S_{ci}[t] - \alpha_1 E_b[t] \\ A[t + 1] = A[t] - A_d[t] + \alpha_1 E_b[t] - \alpha_2 A_b[t] - A_j[t] \\ I[t + 1] = I[t] - I_d[t] + \alpha_2 A_b[t] - I_j[t] \\ J[t + 1] = J[t] + A_j[t] + I_j[t] \end{cases}$$

We take the sets of the in-the-room transmission as subsets of the corresponding compartments. The in-the-room transmission may occur when a person has been infected outside the room, and his roommate is susceptible at time t. Therefore, the number of exposed people whose roommate is susceptible ( $E_r[t]$ ) increases by the susceptible people infected outside the room and decreases by the roommates infected outside the room and the people becoming asymptomatic. In mathematics,

$$E_r[t + 1] = E_r[t] - E_{rd}[t] + NewE_r[t] - S_{co}[t] \cdot \frac{S_{Erb}[t]}{S_b[t]} - \alpha_1 E_{rb}[t]$$

Similarly, the number of asymptomatic people whose roommate is susceptible ( $A_r[t]$ ) increases by the change of exposed people whose roommate is susceptible ( $E_r[t]$ ), and decreases by the roommates infected outside or inside the room, the isolation, and the people becoming infectious. In mathematics,

$$A_r[t + 1] = A_r[t] - A_{rd}[t] + \alpha_1 E_{rb}[t] - S_{co}[t] \cdot \frac{S_{Arb}[t]}{S_b[t]} - \beta_{r1}A_{rb}[t] - \alpha_2 A_{rb}[t] - A_j[t] \cdot \frac{A_{rb}[t]}{A_b[t]}$$

The number of infectious people whose roommate is susceptible ( $I_r[t]$ ) increases by the change of asymptomatic people whose roommate is susceptible ( $A_r[t]$ ), and decreases by the roommates infected outside or inside the room, as well as isolation.

$$I_r[t + 1] = I_r[t] - I_{rd}[t] + \alpha_2 A_{rb}[t] - S_{co}[t] \cdot \frac{S_{rb}[t]}{S_b[t]} - \beta_{r2} I_r[t] - I_j[t] \cdot \frac{I_{rb}[t]}{I_b[t]}$$

The following algorithm calculates the number of new exposed people whose roommate is susceptible at time  $t$  ( $NewE_r[t]$ ).

*Algorithm for the expectation of  $NewE_r[t]$  in a double room*

Total susceptible people infected outside rooms at time  $t$  is  $S_{co}[t]$ . The number of susceptible people whose roommate is also susceptible in a double room at time  $t$  is  $S_{Srb}[t]$ . The total number of susceptible people onboard at time  $t$  is  $S_b[t]$ . So, the algorithm for the expectation of  $NewE_r[t]$  is

$$\left\{ \begin{array}{l} E = S_{co}[t] \cdot \frac{S_{Srb}[t]}{S_b[t]} \\ Prob(E) = \frac{E}{S_{Srb}[t]} \\ Prob(S) = 1 - Prob(E) \\ room_S = \frac{S_{Srb}[t]}{2} \\ p = 2Prob(E)Prob(S) \\ room_E = room_S \cdot p \\ NewE_r[t] = room_E \cdot 1 \end{array} \right.$$

Among them,  $E$  is the number of susceptible people whose roommate is also susceptible infected outside the room.

*The heterogeneous SEAIJ epidemic model with different transmission schemes, different identities, different-size rooms, and the anthropogenic intervention on a cruise ship given daily data*

The heterogeneous model in the previous section assumes there is only 1 identity on the cruise ship. However, there are 2 identities: the passengers and the crew members. That is the case introduced in this section.

We are supposed that passengers lived in the double rooms and the crew lived in the triple rooms on the cruise ship. If one of the crew members living in the triple room disembarks, the triple room will become a double room. Since the sets of the inside-the-room transmission are subsets of the corresponding sets, we calculate the changes in the number of passenger sets and the crew sets separately. Moreover, a double room's transmission is different from a triple room's, so we individually consider the changes in the number of double-room sets and triple-room sets.

The number of susceptible passengers infected outside rooms is affected by infected passengers ( $A_{pb}, I_{pb}$ ) and the infected crew ( $A_{wb}, I_{wb}$ ). The number of susceptible passengers infected inside rooms is the same as the above. In mathematics,

$$S_{pco}[t] = \frac{\beta_1 A_{pb}[t] c_{pp}[t] S_{pb}[t]}{N_{pb}[t]} + \frac{\beta_1 A_{wb}[t] c_{wp}[t] S_{pb}[t]}{N_{pb}[t]} + \frac{\beta_2 I_{pb}[t] c_{pp}[t] S_{pb}[t]}{N_{pb}[t]} + \frac{\beta_2 I_{wb}[t] c_{wp}[t] S_{pb}[t]}{N_{pb}[t]}$$

$$S_{pci}[t] = \beta_{r1} A_{ps}[t] + \beta_{r2} I_{ps}[t]$$

Similarly, the number of susceptible crew members infected at time  $t$  is calculated by

$$S_{2wco}[t] = \frac{\beta_1 A_{pb}[t] c_{pw}[t] S_{2wb}[t]}{N_{wb}[t]} + \frac{\beta_1 A_{wb}[t] c_{ww}[t] S_{2wb}[t]}{N_{wb}[t]} + \frac{\beta_2 I_{pb}[t] c_{pw}[t] S_{2wb}[t]}{N_{wb}[t]} + \frac{\beta_2 I_{wb}[t] c_{ww}[t] S_{2wb}[t]}{N_{wb}[t]}$$

$$S_{2wci}[t] = \beta_{r1} A_{2ws}[t] + \beta_{r2} I_{2ws}[t]$$

$$S_{3wco}[t] = \frac{\beta_1 A_{pb}[t] c_{pw}[t] S_{3wb}[t]}{N_{wb}[t]} + \frac{\beta_1 A_{wb}[t] c_{ww}[t] S_{3wb}[t]}{N_{wb}[t]} + \frac{\beta_2 I_{pb}[t] c_{pw}[t] S_{3wb}[t]}{N_{wb}[t]} + \frac{\beta_2 I_{wb}[t] c_{ww}[t] S_{3wb}[t]}{N_{wb}[t]}$$

The triple-room transmission may occur when there is at least one susceptible person and at least one infection source in the same room. In mathematics,

$$S_{3wci}[t] = 2\beta_{r1}A_{3wSS}[t] + 2\beta_{r2}I_{3wSS}[t] + \beta_{r1}A_{3wSE}[t] + \beta_{r2}I_{3wSE}[t] + \beta_{r1}A_{3wSA}[t] + \beta_{r2}I_{3wSA}[t] + \beta_{r1}A_{3wSI}[t] + \beta_{r2}I_{3wSI}[t]$$

Then the change in the number of susceptible people infected inside and outside the room is the summation of the changes in the number of susceptible passengers and crew members infected inside and outside the room, respectively.

$$S_{co}[t] = S_{pco}[t] + S_{2wco}[t] + S_{3wco}[t]$$

$$S_{ci}[t] = S_{pci}[t] + S_{2wci}[t] + S_{3wci}[t]$$

The remaining representation of the heterogeneous SEAIJ epidemic model is the same as the previous section, i.e.,

$$\begin{cases} S[t + 1] = S[t] - S_d[t] - S_{co}[t] - S_{ci}[t] \\ E[t + 1] = E[t] - E_d[t] + S_{co}[t] + S_{ci}[t] - \alpha_1 E_b[t] \\ A[t + 1] = A[t] - A_d[t] + \alpha_1 E_b[t] - \alpha_2 A_b[t] - A_j[t] \\ I[t + 1] = I[t] - I_d[t] + \alpha_2 A_b[t] - I_j[t] \\ J[t + 1] = J[t] + A_j[t] + I_j[t] \end{cases}$$

The number of newly exposed people whose roommates are both susceptible at time t ( $NewE_r[t]$ ) in a triple room is different from the double rooms (2 susceptible people versus 1 infection source and 1 susceptible person versus 2 infection sources.)

*Algorithm for the expectation of  $NewE_r[t]$  in a triple room*

Total susceptible people infected outside the room at time t is  $S_{co}[t]$ . The number of susceptible people whose roommates are both susceptible in a triple room at time t is  $S_{SSrb}[t]$ . The total number of susceptible people onboard at time t is  $S_b[t]$ . Therefore, the algorithm for the expectation of  $NewE_r[t]$  is:

$$\begin{cases} E = S_{co}[t] \cdot \frac{S_{SSrb}[t]}{S_b[t]} \\ Prob(E) = \frac{E}{S_{SSrb}[t]} \\ Prob(S) = 1 - Prob(E) \\ room_S = \frac{S_{SSrb}[t]}{3} \\ p_1 = 3Prob(E) \cdot (Prob(S))^2 \\ room_{E1} = S_{room} \cdot p_1 \\ NewE_{r1}[t] = room_{E1} \\ p_2 = 3(Prob(E))^2 \cdot Prob(S) \\ room_{E2} = S_{room} \cdot p_2 \\ NewE_{r2}[t] = 2room_{E2} \end{cases}$$

Among them,  $p_1$  is the probability that one of the three susceptible people living in the same room becomes exposed. However, another two are still susceptible,  $room_{E1}$  is the number of rooms that one of the three susceptible people living in the same room becomes exposed, but another two are still susceptible,  $NewE_{r1}$  is the number of newly exposed people whose roommates are both susceptible in a triple room,  $p_2$  is the probability that two of the three susceptible people living in the same room become exposed, but another one is still susceptible,  $room_{E2}$  is the number of rooms that two of the three susceptible people living in the same room become exposed, but another one is still susceptible, and  $NewE_{r2}$  is the number of newly exposed people, one of whose roommates is exposed and the other is susceptible.

The algorithm of changes in other compartments related to the in-the-room transmission is similar to  $NewEr[t]$ 's.

**Fig. 1(a)** shows the number of susceptible people on board. In the first two stages (Day 1 to Day 5), the line is smooth since people infected by the original patient were in the incubation period at this time. In the third stage (Day 6 to Day 16), the number decreases due to the increasing number of infected people and symptomatic (I) people. In the fourth stage (Day 17 to Day 28), the downward trend of the line slows down due to the decrease of close contacts. In the fifth stage (Day 29 to Day 42), the line has a few big jumps due to the disembarkation of people.

**Fig. 1(b)** shows the number of exposed people on board. In the first stage (Day 1 to Day 3), the number increases slowly since no more than 6 people infected by and along with the original patient were able to infect susceptible people. In the

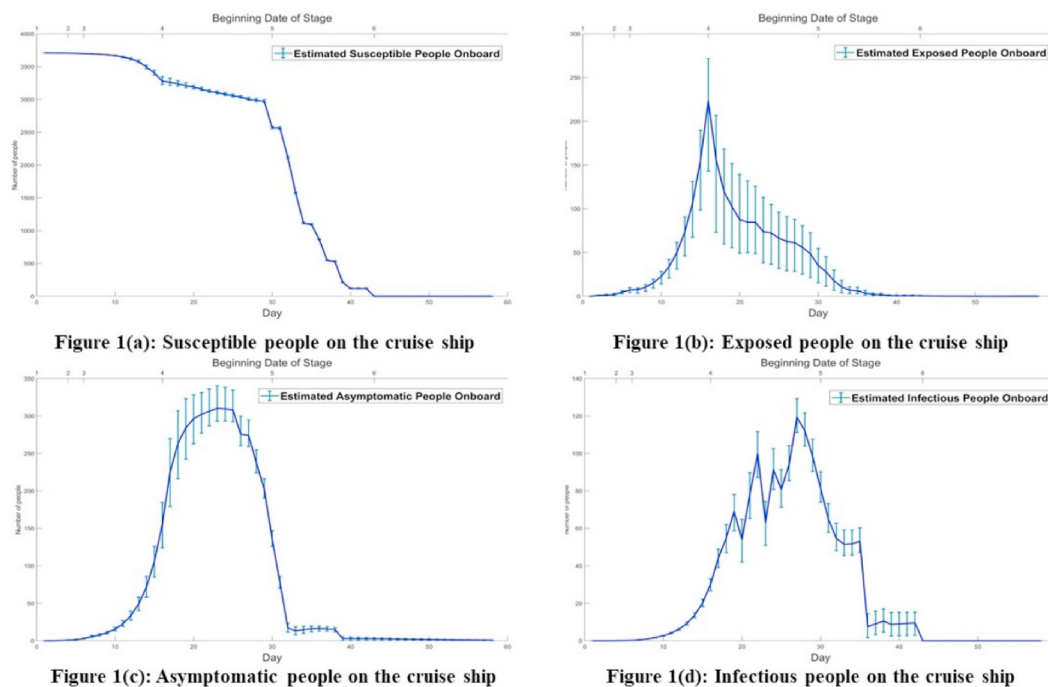

**Fig. 1.** Dynamic changes in compartment S, E, A, and I.

second stage (Day 4 to Day 5), the upward trend of the line is faster than the first stage since the original patient developed symptoms and was more contagious; thus, the number of asymptomatic people increased. In the third stage (Day 6 to Day 16), the number jumps sharply on Day 7 but grows fast since Day 8. Since the original patient disembarked, so the increasing number of exposed people was less than the number of exposed people who became asymptomatic on Day 7. As more patients develop symptoms and become more contagious, the scale of exposed people grows larger than in previous days. In the fourth stage (Day 17 to Day 28), the line is volatile due to the isolation of patients. In the fifth stage (Day 29 to Day 42), the number sharply decreases since some exposed people disembarked and the number of close contacts decreased.

Fig. 1(c) shows the number of asymptomatic people, starting from 0 since we do not count the original patient. That is the same as reported data since the original patient is counted in Hong Kong. The number increases slowly in the first two stages (Day 1 to Day 5). In the third stage (Day 6 to Day 16), the upward trend of the line grows faster. The number of asymptomatic people on Day 8 increases slowly due to the disembarkation of the original patient and the gradually increasing number of exposed people. In the fourth stage (Day 17 to Day 28), the upward trend of the line is slower until there are some sharp jumps due to the isolation of asymptomatic patients and the decreasing number of newly exposed people. In the fifth stage (Day 29 to Day 42), the line is volatile due to the disembarkation of susceptible people, isolation of asymptomatic people, and decreasing number of exposed people.

Fig. 1(d) shows the number of infectious people. In the first two stages (Day 1 to Day 5), the number of infectious people is around 0 since the infected people were all in the incubation period. In the third stage (Day 6 to Day 16), the line's upward is grows faster. In the fourth stage (Day 17 to Day 28), the line is volatile due to the isolation of infectious patients and the transformation of asymptomatic patients. In the fifth stage (Day 29 to Day 42), the number sharply decreases since more infectious patients were diagnosed and isolated from the population than in the fourth stage. The isolation of asymptomatic people also slowed down the growth of infectious patients.

Fig. 2 shows the daily number of passengers that a crew member has close contact with on average, calculated by Equation (20). Before isolation, it is a horizontal line due to a relatively stable number of passengers and crew members on board. This number ranges from 6 to 21, which is affected by the volatile daily number of crew members that a passenger has close contact with ( $c_{pw}$ ). In the fourth stage (Day 17 to Day 28), the line is horizontal but down to around 0.28 since the value of  $c_{pw2}$  is less than 1. In the fifth stage (Day 29 to Day 42), the line is volatile due to the varying number of passengers and crew members on board during the disembarkation period.

Fig. 3 (a) shows the cumulative number of cases, which is calculated by the sum of the number of new infectious (I) patients and new isolated asymptomatic (A) patients. The gap between the estimated number and the blue line is the infectious patients who were not diagnosed on board. No patients developed symptoms in the first two stages (Day 1 to Day 5) in the first two stages. The number increases sharply in the third and fourth stages (Day 6 to Day 28). Big jumps occur due to the isolation of asymptomatic patients. The line is relatively smooth in the fifth stage (Day 29 to Day 42) since the number of

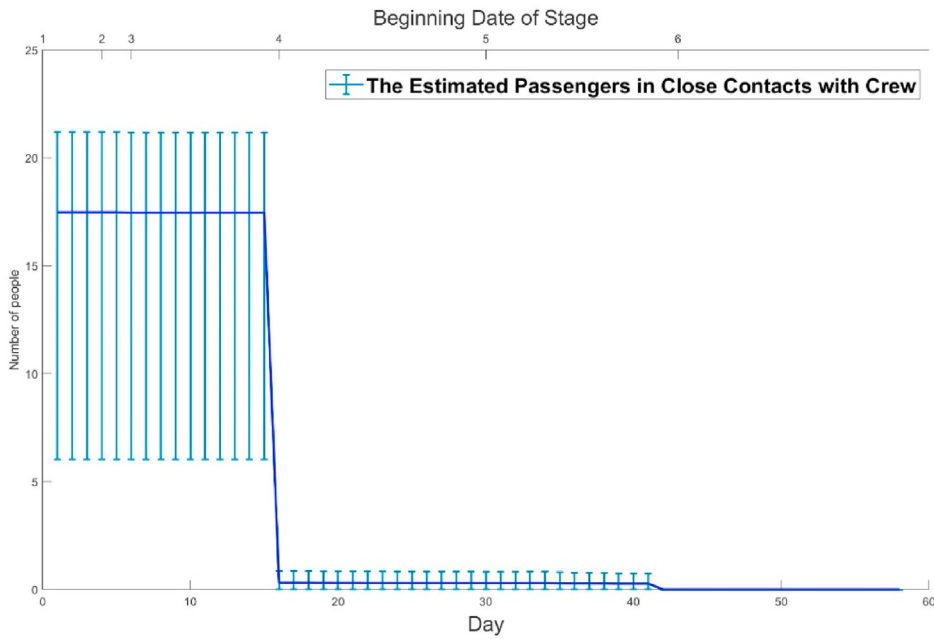

Fig. 2. The daily number of passengers that each crew member close contacts with on average.

newly infected people decreased after isolation. In the sixth stage (Day 43 to Day 57), the line is nearly horizontal since only one patient tested positive during the observation period. The number of reported cases increased by 15 on the last day, which disembarked during the non-incubation period. This is the reason why our final cumulative case is less than the total number of reported cases.

Fig. 3 (b) shows the cumulative number of people infected inside the room. No people were infected inside the room in the first stage (Day 1 to Day 3). The number increases slowly in the second and third stages (Day 4 to Day 16). In the fourth stage (Day 17 to Day 28), the number increases sharply at the beginning and then slows down due to patients' isolation. Around 75% of patients infected inside the room were infected at this stage. In the fifth stage (Day 29 to Day 42), the in-the-room transmission occurs only in the first three days. The line is horizontal after Day 31. Around 10% of patients infected inside the room were infected in these three days.

Fig. 4 shows the daily number of people infected by the original patient. In the first stage (Day 1 to Day 3), the original patient infected around 0.78 people per day on average during the infectious incubation period. It is the same as the number of people infected by an asymptomatic passenger. In the second stage (Day 4 to Day 5), the original patient infected around 2.85 people every day on average during the symptomatic period. It is the same as the number of people infected by an infectious passenger.

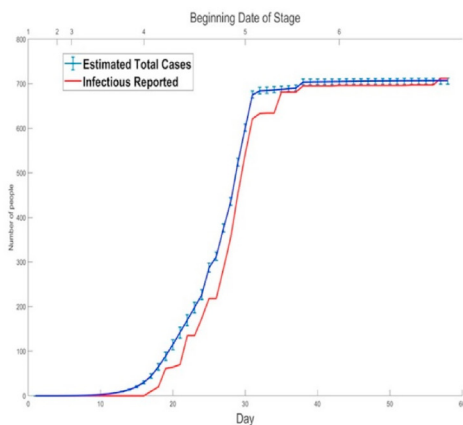

Figure 3(a): Cumulative cases on the cruise ship

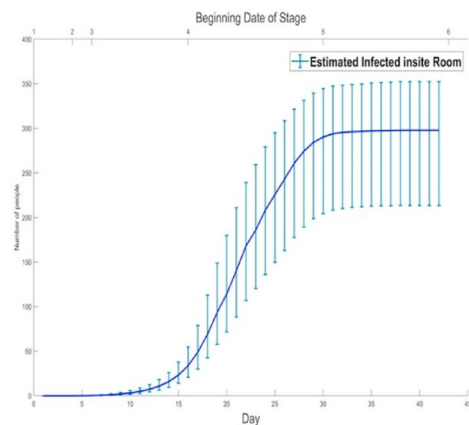

Figure 3(b): Cumulative susceptible people infected in the room

Fig. 3. Cumulative cases.

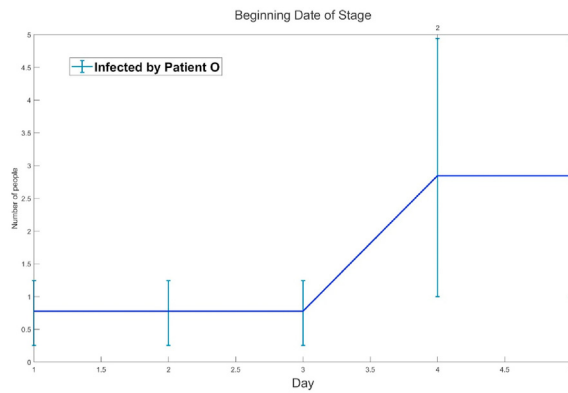

Fig. 4. The daily number of people infected by Patient O.

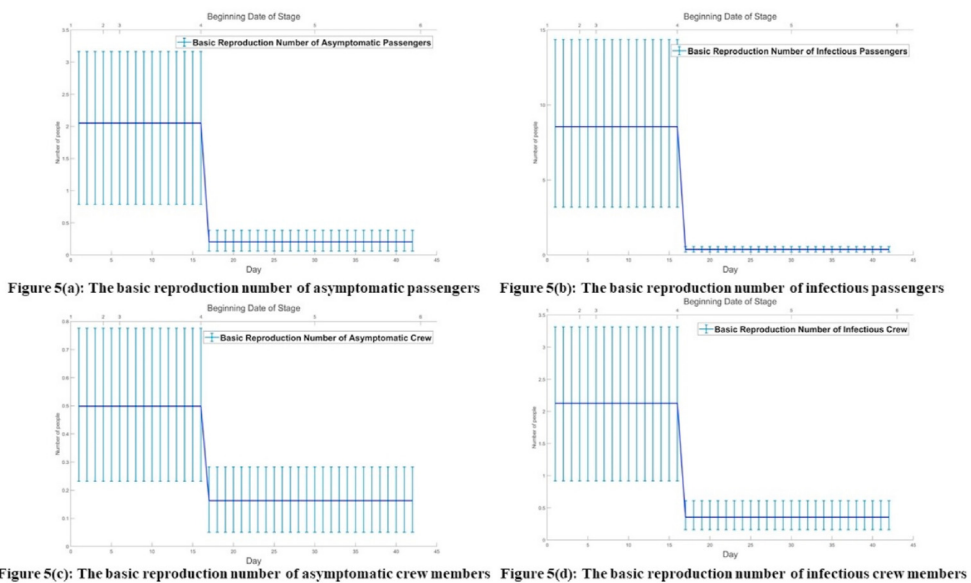

Figure 5(a): The basic reproduction number of asymptomatic passengers    Figure 5(b): The basic reproduction number of infectious passengers  
 Figure 5(c): The basic reproduction number of asymptomatic crew members    Figure 5(d): The basic reproduction number of infectious crew members

Fig. 5. The basic reproduction number of infection sources.

Fig. 5 shows the basic reproduction number of asymptomatic passengers and crew members, as well as infectious passengers and crew members. Volatilities of the reproduction numbers before isolation are more significant than that of after isolation. According to the basic reproduction number formula,  $R_0$  is related to the infection rate, the number of close contacts, and the length of the incubation period. As the three variables are randomly sampled and vary over time,  $R_0$  is not constant in the first three stages.

References

Azimi, P., Keshavarz, Z., Cedeno Laurent, J. G., Stephens, B., & Allen, J. G. (2021). Mechanistic transmission modeling of COVID-19 on the Diamond Princess cruise ship demonstrates the importance of aerosol transmission. *Proceedings of the National Academy of Sciences*, 118, Article e2015482118.

Bertsimas, D., Boussioux, L., Cory-Wright, R., Delarue, A., Digalakis, V., Jacquillat, A., Kitane, D. L., Lukin, G., Li, M., Mingardi, L., et al. (2021). From predictions to prescriptions: A data-driven response to COVID-19. *Health Care Management Science*, 24, 253–272.

Chu, D. K., Akl, E. A., Duda, S., Solo, K., Yaacoub, S., & Schünemann, H. J. (2020). Physical distancing, face masks, and eye protection to prevent person-to-person transmission of SARS-CoV-2 and COVID-19: A systematic review and meta-analysis. *Lancet*, 395, 1973–1987.

Emery, J. C., Russell, T. W., Liu, Y., Hellewell, J., Pearson, C. A., Knight, G. M., Eggo, R. M., Kucharski, A. J., Funk, S., Flasche, S., et al. (2020). The contribution of asymptomatic SARS-CoV-2 infections to transmission on the Diamond Princess cruise ship. *Elife*, 9, Article e58699.

Gan, N., Thomas, N., & Culver, D. (2020). Over 1,700 frontline medics infected with coronavirus in China, presenting new crisis for the government. Available from <https://edition.cnn.com/2020/02/13/asia/coronavirus-health-care-workers-infected-intl-hnk/index.html>. (Accessed 24 February 2020).

Huang, L. S., Li, L., Dunn, L., & He, M. (2021). Taking account of asymptomatic infections: A modeling study of the COVID-19 outbreak on the diamond princess cruise ship. *PLoS One*, 16, Article e0248273.

Ivorra, B., Ferrández, M. R., Vela-Pérez, M., & Ramos, A. M. (2020). Mathematical modeling of the spread of the coronavirus disease 2019 (COVID-19) taking into account the undetected infections. The case of China. *Communications in Nonlinear Science and Numerical Simulation*, 88, 105303-105303.

- Kim, N. (2020). 'It's ruining everyone': Eerie quiet reigns in coronavirus-hit south Korean city. *The Guardian*. Available from <https://edition.cnn.com/2020/02/13/asia/coronavirus-health-care-workers-infected-intl-hnk/index.html>. (Accessed 20 February 2020).
- Lin, Q., Zhao, S., Gao, D., Lou, Y., Yang, S., Musa, S. S., Wang, M. H., Cai, Y., Wang, W., Yang, L., et al. (2020). A conceptual model for the coronavirus disease 2019 (COVID-19) outbreak in Wuhan, China with individual reaction and governmental action. *International Journal of Infectious Diseases*, 93, 211–216.
- Liu, F., Li, X., & Zhu, G. (2020b). Using the contact network model and Metropolis-Hastings sampling to reconstruct the COVID-19 spread on the "Diamond Princess". *Science Bulletin*, 65, 1297–1305.
- Liu, Z., Magal, P., Seydi, O., & Webb, G. (2020a). A COVID-19 epidemic model with latency period. *Infect Dis Model*, 5, 323–337.
- Mizumoto, K., Kagaya, K., Zarebski, A., & Chowell, G. (2020). Estimating the asymptomatic proportion of coronavirus disease 2019 (COVID-19) cases on board the Diamond Princess cruise ship, Yokohama, Japan, 2020. *Euro Surveillance*, 25, 2000180.
- Morton, A., Bish, E., Megiddo, I., Zhuang, W., Aringhieri, R., Brailsford, S., Deo, S., Geng, N., Hagle, J., Hutton, D., et al. (2021). Introduction to the special issue: Management science in the fight against COVID-19. *Health Care Management Science*, 24, 251–252.
- Rocklöv, J., Sjödin, H., & Wilder-Smith, A. (2020a). COVID-19 outbreak on the diamond princess cruise ship: Estimating the epidemic potential and effectiveness of public health countermeasures. *Journal of Travel Medicine*, 27, taaa030.
- Rocklöv, J., Sjödin, H., & Wilder-Smith, A. (2020b). COVID-19 outbreak on the diamond princess cruise ship: Estimating the epidemic potential and effectiveness of public health countermeasures. *Journal of Travel Medicine*, 27, taaa030.
- Ross, R. (1910). *The prevention of malaria* (1st ed.). London: J. Murray.
- WHO. (2020). Coronavirus disease (COVID-2019) situation reports. <https://www.who.int/emergencies/diseases/novel-coronavirus-2019/situation-reports/>.
- Yao, H., Lu, X., Chen, Q., Xu, K., Chen, Y., Cheng, L., et al. (2020). Patient-derived mutations impact pathogenicity of SARS-CoV-2. Available at SSRN: <https://ssrn.com/abstract=3578153>.